

STIHL

STIHL HT-KM

Instruction Manual



Contents

KombiSystem	2
Guide to Using this Manual	2
Safety Precautions and Working Techniques	2
Using the Unit	6
Approved KombiEngines	8
Assembling the Unit	9
Mounting the KombiTool	10
Cutting Attachment	10
Mounting the Bar and Chain	11
Tensioning the Chain	12
Checking Chain Tension	12
Chain Lubricant	12
Filling Chain Oil Tank	13
Checking Chain Lubrication	15
Fitting the Harness	15
Starting / Stopping the Engine	16
Operating Instructions	17
Taking Care of the Guide Bar	17
Storing the Machine	18
Checking and Replacing the Chain Sprocket	18
Maintaining and Sharpening the Saw Chain	19
Maintenance and Care	23
Minimize Wear and Avoid Damage	24
Main Parts	25
Specifications	26
Maintenance and Repairs	27
Disposal	27
EC Declaration of Conformity	28
UKCA Declaration of Conformity	29

STIHL

Dear Customer,

Thank you for choosing a quality engineered STIHL product.

It has been built using modern production techniques and comprehensive quality assurance. Every effort has been made to ensure your satisfaction and trouble-free use of the product.

Please contact your dealer or our sales company if you have any queries concerning this product.

Your



Dr. Nikolas Stihl

KombiSystem

In the STIHL KombiSystem a number of different KombiEngines and KombiTools can be combined to produce a power tool. In this instruction manual the functional unit formed by the KombiEngine **and** KombiTool is referred to as the power tool.

Therefore, the separate instruction manuals for the KombiEngine and KombiTool should be used together for the power tool.

Always read and and make sure you understand **both** instruction manuals before using your power tool for the first time and keep them in a safe place for future reference.

Guide to Using this Manual

Pictograms

All the pictograms attached to the machine are shown and explained in this manual.

Symbols in text



Warning where there is a risk of an accident or personal injury or serious damage to property.



Caution where there is a risk of damaging the machine or its individual components.

Engineering improvements

STIHL's philosophy is to continually improve all of its products. For this reason we may modify the design, engineering and appearance of our products periodically.

Therefore, some changes, modifications and improvements may not be covered in this manual.

Safety Precautions and Working Techniques



Special safety precautions must be observed when working with the pole pruner because it operates at a very high chain speed, has very sharp cutters and a long reach.



Both user manuals (KombiEngine and KombiTool) must be read through attentively before using the unit for the first time and kept in a safe place for future reference. Non-compliance with the user manuals may cause serious or even fatal injury.

The machine should only be provided or loaned to people familiar with this model and its operation. The KombiEngine and KombiTool user manuals should always be handed over with the machine.

Use your pole pruner for limbing only (removing or pruning branches). Saw wood and wooden objects only.

The machine must not be used for any other purposes – **risk of accidents!**

Only use guide bars, saw chains, chain sprockets and accessories that are explicitly approved for this power tool model by STIHL or are technically identical. If you have any questions in this respect, consult your dealer.

Use only high quality parts and accessories. in order to avoid the risk of accidents and damage to the machine.

STIHL recommends the use of STIHL original tools, guide bars, saw chains, chain sprockets and accessories. They are specifically designed to match the product and meet your performance requirements.

Never attempt to modify your power tool in any way since this may increase the risk of personal injury. STIHL excludes all liability for personal injury and damage to property caused while using unauthorized attachments.

Do not use a high-pressure washer to clean the power tool. The solid jet of water may damage parts of the unit.

Clothing and equipment

Wear proper protective clothing and equipment.



Clothing must be sturdy but allow complete freedom of movement. Wear snug-fitting clothing, e.g. an overall and jacket combination, do not wear a work coat.

Do not wear clothing which could become trapped in wood, brush or moving parts of the machine. Do not wear a scarf, necktie or jewelry. Tie up and confine long hair above your shoulders.



Wear cut protection safety boots with non-slip soles and steel toe caps.

WARNING



To reduce the risk of eye injuries, wear close-fitting safety glasses in accordance with European Standard EN 166. Make sure the safety glasses are a snug fit.

Wear "personal" sound protection, e.g. ear defenders.

Wear a safety hard hat where there is a danger of head injuries from falling objects.



Wear sturdy protective gloves made of a resistant material (e. g. leather).

STIHL can supply a comprehensive range of personal protective equipment.

Transporting the machine

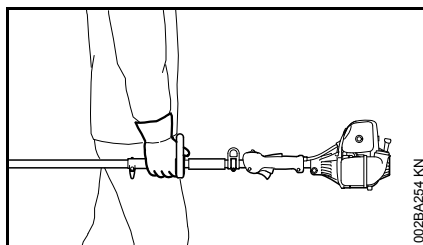

Always stop the engine.

Always fit the chain scabbard – even when you carry the power tool for short distances.

Ensure that the power tool is always well balanced and hold it by the shaft for carrying.

Do not touch hot parts of the machine - **risk of burn injury!**

By vehicle: When transporting in a vehicle, properly secure your machine to prevent turnover, damage and fuel spillage.

Before starting

Check that your power tool is properly assembled and in good condition – refer to appropriate chapters in the KombiEngine and KombiTool user manuals.

- Correctly mounted guide bar
- Correctly tensioned saw chain
- Never attempt to modify the controls or safety devices
- Keep the handles dry and clean – free from oil and dirt – this is important for safe control of the machine
- Adjust carrying harness and handles in accordance with body height. Observe the chapter "Fitting the Harness"

To reduce the risk of personal injury, do not operate your power tool if it is damaged or not properly assembled!

To prepare for emergencies when using a harness: Practice setting down the machine quickly. To avoid damage, do not throw the machine to the ground when practicing.

See also notes on "Before Starting" in the user manual of the KombiEngine you are using.

Holding and guiding the machine

Make sure you always have good balance and secure footing.

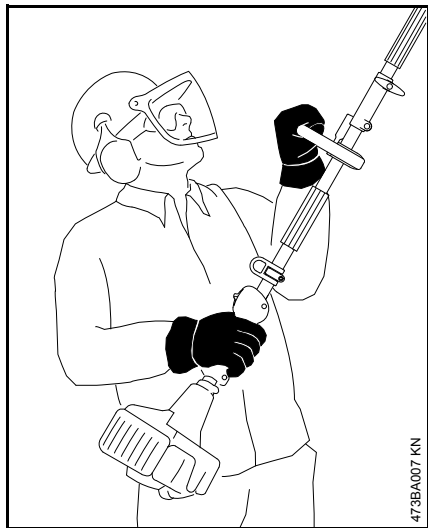

Always hold your power tool firmly with both hands:

Right hand on control handle, left hand on the loop handle or handle hose, even if you are left-handed. Wrap your fingers and thumbs around the handles.

With the KM 94 R KombiEngine, always use the handle hose of the KombiTool as the left handle.

While working

In the event of impending danger or in an emergency, switch off the engine immediately by moving the slide control / stop switch/button to **0** or **STOP**.



This power tool is not insulated. Keep at least 15 m away from electric power lines – **Danger of fatal electric shock!**

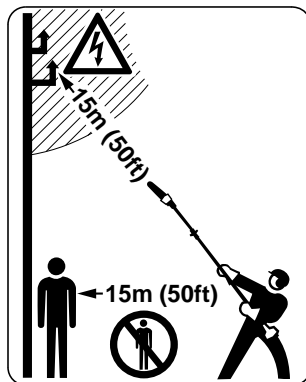

Do not allow other persons within a radius of 15 m of your own position due to falling branches and ejected wood particles – **Risk of injury!** This distance must also be maintained in relation to objects (vehicles, window panes) – **risk of property damage!**

Keep the bar nose at least 15 m away from electric power lines. Electric current may also arc over from high-voltage cables at greater distance. Have the power switched off before starting work in the immediate vicinity of power lines.

Ensure that the engine idling speed is correct. The saw chain must not move when the throttle trigger has been released.

Check and correct the idle speed setting at regular intervals. If the saw chain still rotates, have your dealer check your machine and make proper adjustments or repairs – see the user manual of the KombiEngine.

Take special care in slippery, wet conditions, in snow and on slopes, uneven ground, etc. – **Risk of slipping!**



The gear head becomes hot during operation. **To reduce the risk of burn injury, do not touch the gear housing!**

Watch out for obstacles: tree stumps, roots – **risk of tripping or stumbling!**

Make sure you always have good balance and secure footing.

When working at heights:

- Always use a lift bucket
- Never use the machine while standing on a ladder or in a tree
- Never work on an insecure support
- Never use the machine with just one hand

Be particularly alert and cautious when wearing hearing protection because your ability to hear warnings (shouts, alarms, etc.) is restricted.

Take breaks when you start getting tired or feeling fatigue – **risk of accidents!**

Work calmly and carefully – in daylight conditions and only when visibility is good. Proceed with caution, do not put others in danger.

Dust (e. g., sawdust), fumes and smoke produced while using the machine may be hazardous to health. If dust levels are high, wear a suitable respirator.

Do not touch the saw chain while the engine is running. If the saw chain becomes jammed by an obstruction, switch off the engine immediately before attempting to remove the obstruction – **risk of injury**.

Opening the throttle while the saw chain is blocked increases the load and reduces engine speed. The clutch then slips continuously and this causes overheating and damage to important components (e.g. clutch, polymer housing components) – **and this can increase the risk of injury from the saw chain moving while the engine is idling**.

If your power tool is subjected to unusually high loads for which it was not designed (e.g. heavy impact or a fall), always check that it is in good condition before continuing work – see also "Before Starting". Make sure the safety devices are working properly. Never use a power tool that is no longer safe to operate. In case of doubt, contact a dealer.

To reduce the risk of injury, switch off the engine before changing the saw chain.

If you use a harness, ensure that the exhaust gas flow is diverted away from your body – **Risk of fire!**

Limbing

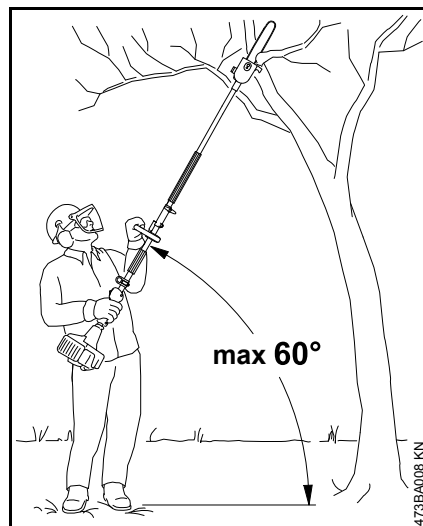

Hold the power tool at an angle. Do not stand directly underneath the limb being cut. Do not exceed an angle of 60° from the horizontal. Watch for falling wood.

Keep the work area clear – remove interfering limbs and brush.

Before sawing branches, establish an escape route and remove all obstacles.

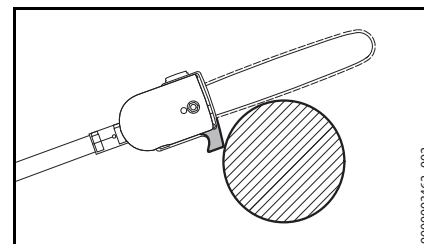

When performing the separating cut, position the bar against the branch near the hook. This will prevent the power tool from making jolting movements when you start the separating cut.

Start the cut with the saw chain at full throttle.

Always cut with a correctly sharpened, properly tensioned saw chain – the depth gauge setting must not be too large.

Perform cross-cut from the top downward to avoid the chain pinching in the cut.

If branch is thick or heavy, make a relieving cut – see chapter on "Using the Pole Pruner".

Exercise extreme caution when sawing branches under tension – **Risk of injury!** Always make a relieving cut on the compression side first and then perform the bucking cut at the tension side.

Be careful when cutting splintered wood – **Risk of injury from ejected pieces of wood!**

If working on a slope, always stand uphill or to the side of the branch which is to be sawn. Watch out for rolling branches.

Note when reaching the end of a cut that the power tool is no longer supported by the guide bar in the cut. The user must bear the weight of the machine – **risk of loss of control!**

Always pull the power tool out of the cut with the saw chain running.

Use the power tool for limbing and pruning only, not for felling – **Risk of accidents!**

Keep the saw chain away from any foreign objects: Stones, nails, etc. may be ejected and damage the saw chain.

If a rotating saw chain hits a stone or another hard object, sparks may be generated which may ignite easily flammable materials under certain conditions. Also dried-out plants and brushwood are combustible, above all in hot and dry weather. If there is a risk of fire, do not use your pole pruner near easily flammable materials, dry plants or scrub. It is mandatory that you ask the responsible forestry office about the current fire hazard.

Maintenance and Repairs

Service the machine regularly. Do not attempt any maintenance or repair work not described in the KombiTool and KombiEngine instruction manuals. Have all other work performed by a servicing dealer.

STIHL recommends that you have servicing and repair work carried out exclusively by an authorized STIHL servicing dealer. STIHL dealers are regularly given the opportunity to attend training courses and are supplied with the necessary technical information.

Only use high-quality replacement parts in order to avoid the risk of accidents and damage to the machine. If you have any questions in this respect, consult a servicing dealer.

STIHL recommends the use of genuine STIHL replacement parts. They are specifically designed to match your model and meet your performance requirements.

To reduce the risk of injury, **always shut off the engine** before carrying out any maintenance or repairs or cleaning the machine. – Exception: Carburetor and idle speed adjustments.

Stopping the engine

- before checking chain tension.
- before retensioning the chain.
- before replacing the chain.
- before rectifying problems.

Observe sharpening instructions – keep the chain and guide bar in good condition at all times for safe and correct handling of the saw. The chain must be properly sharpened, tensioned and well lubricated.

Always change the chain, guide bar and sprocket in good time.

Store chain lubricant in properly labelled, safety-type canisters only.

Using the Unit

Preparation

- Wear suitable protective clothing, observe safety precautions
- Starting the engine
- Fitting the harness

Cutting sequence

To allow branches to free fall, always cut the lower branches first. Prune heavy branches (large diameter) in several controllable pieces.



WARNING

Never stand directly underneath the branch you are cutting – be wary of falling branches. Note that a branch may spring back at you after it hits the ground – **risk of injury**

Disposal

Do not throw cuttings into the garbage can – they can be composted.

Working technique

Hold the control handle with your right hand, and the loop handle with your left hand. Your left arm should be extended to the most comfortable position.

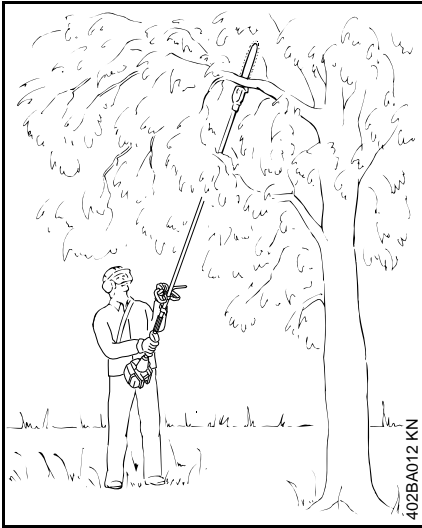

The shaft should always be held at an angle of **60° or less**.

The least tiring working position is a tool angle of 60°.

Any lesser angle may be used to suit the situation.

Cross-cut

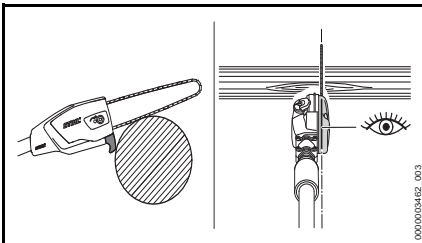

To avoid pinching the bar in the cut, position the cutting attachment with the hook against the branch and then perform the cross-cut from the top

downwards. The saw chain can be positioned precisely using the gauge bar.

Relieving cut

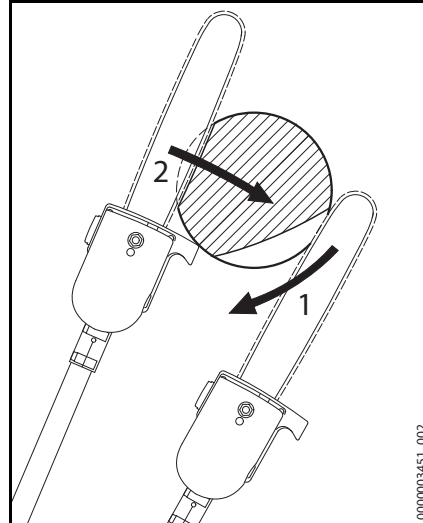

To avoid tearing the bark on thick branches, always start by performing a

- relieving cut (1) on the underside of the branch. To do this, position the cutting attachment and guide it down to the bar nose in an arc.
- Perform the cross-cut (2) – position the bar with the hook against the branch and then perform the cross-cut

Flush-cutting thick branches

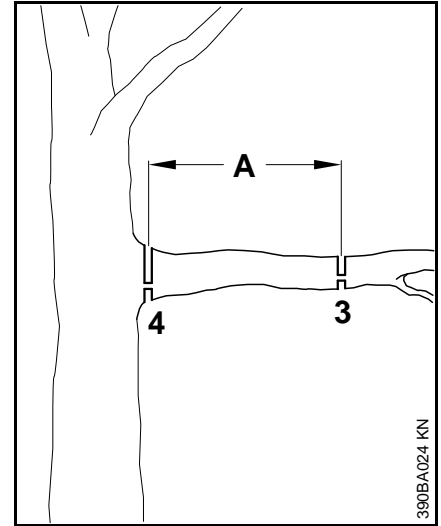

If the branch diameter is more than 10 cm (4 in), first

- perform the undercut (3) and then cross-cut at a distance of about 20 cm/8 in (A) from the final cut. Then carry out the flush-cut (4), starting with a relieving cut and finishing with a cross-cut

Cutting above obstacles

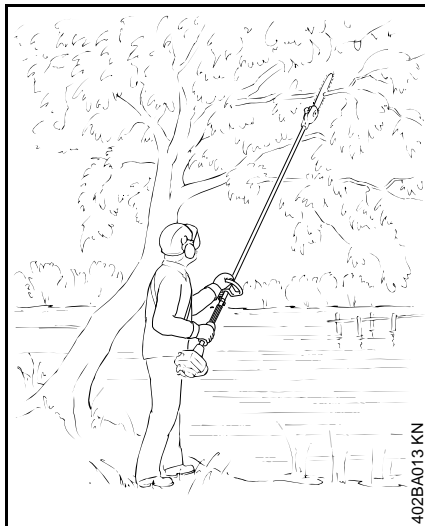

The machine's long reach makes it possible to prune branches that are overhanging obstacles, such as rivers or lakes. The tool angle in this case depends on the position of the branch.

Cutting from a lift bucket

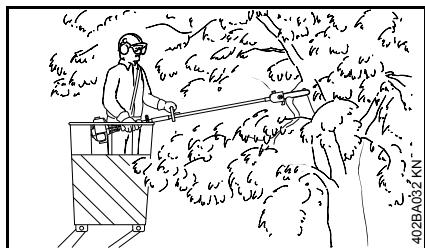

The machine's long reach enables cutting to be performed next to the trunk without the risk of the lift bucket damaging other branches. The tool angle in this case depends on the position of the branch.

30° angle drive (special accessory)

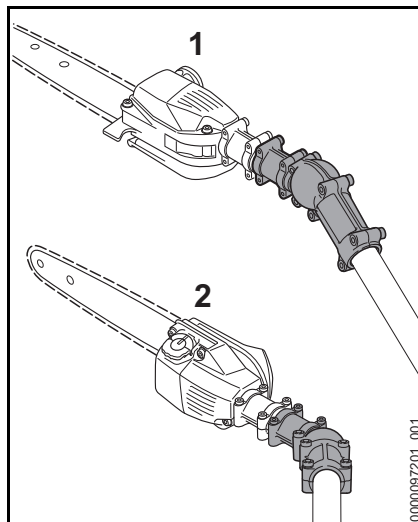

The angle drive keeps the cutting attachment at an angle of 30° to the shaft.

The angle drive may be adjusted on the shaft to the following positions only:

- 1 for cross-cutting vertical branches and bushes
- 2 for a better view of the cutting attachment

Approved KombiEngines

KombiEngines

Only use KombiEngines supplied or explicitly approved by STIHL for use with the attachment.

This KombiTool may be operated only in combination with the following KombiEngines:

STIHL KM 56 R, KM 85 R, KM 94 R, KM 111 R, KM 131 R, KMA 130 R, KMA 135 R



WARNING

Loop-handled machines must be equipped with a barrier bar.

Brushcutters with split boom

The KombiTool can also be fitted to STIHL brushcutters with a split shaft (T-models) (basic power tools).

This KombiTool can therefore also be used on the following machine:

STIHL FR 131 T



WARNING

Refer to the User Manual of the power tool for use of the barrier bar.

Assembling the Unit

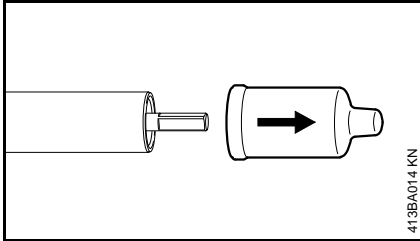

413BA014 KN

- Pull the protective caps off the ends of the shaft and keep them in a safe place for later use – see "Storing the Machine"

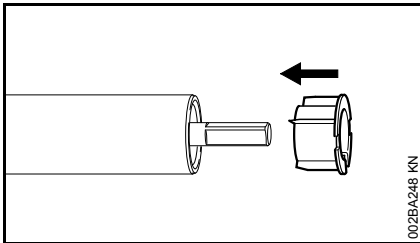

002BA248 KN

NOTICE

The plug may come out of the drive tube when you pull off the cap. Push it back into the shaft as far as it will go.

Mounting the gearbox

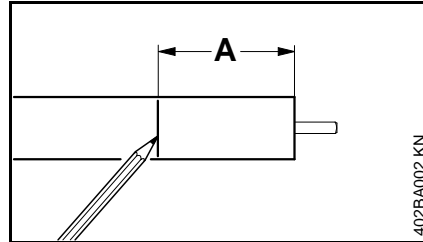

402BA002 KN

- Apply a mark to the shaft at distance (A) of 50 mm (2 in.)

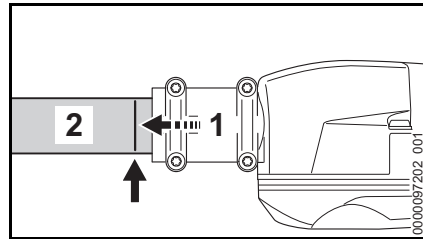

0000097202_001

- Push the gearbox (1) onto the shaft (2) as far as stop – turn the gearbox back and forth until the square end of the shaft engages

The gearbox is correctly positioned when the end of its housing reaches or covers the mark (arrow).

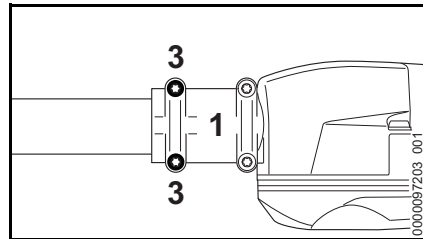

0000097203_001

- Insert the clamp screws (3) as far as it will go

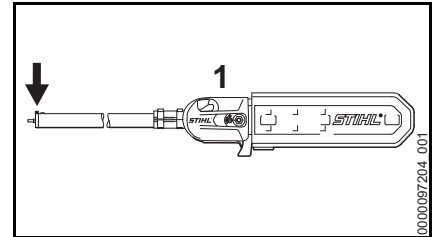

0000097204_001

- Line up the gearbox (1) so that the chain sprocket cover is exactly vertical and the lug (arrow) on the end of the drive tube faces up
- Tighten down the clamp screws (3) in the following sequence:
 - tighten the left screw moderately
 - tighten the right screw moderately
 - tighten down the left screw **firmly**
 - tighten down the right screw **firmly**

Mounting the KombiTool

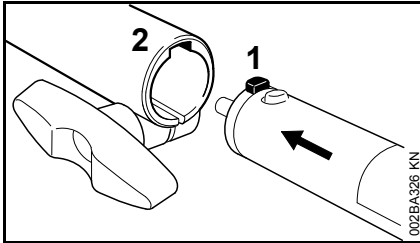

- Push the lug (1) on the drive tube into the slot (2) in the coupling sleeve as far as stop.

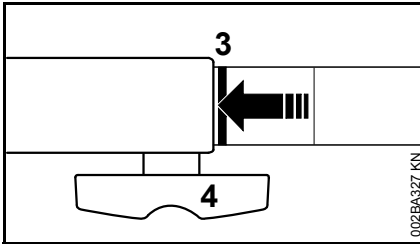

When correctly installed, the red line (3) (arrow point) must be flush with the end of the coupling sleeve.

- Tighten down the star knob (4) **firmly**.

Removing the KombiTool

- Reverse the above sequence to remove the drive tube.

Cutting Attachment

A cutting attachment consists of the saw chain, guide bar and chain sprocket.

The cutting attachment that comes standard is designed to exactly match the pole pruner.

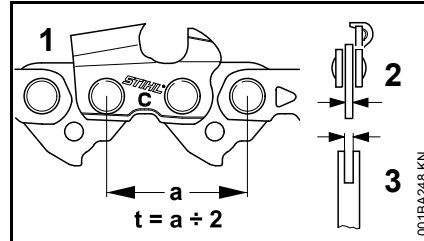

- The pitch (t) of the saw chain (1), chain sprocket and the nose sprocket of the Rollomatic guide bar must match.
- The drive link gauge (2) of the saw chain (1) must match the groove width of the guide bar (3).

If non-matching components are used, the cutting attachment may be damaged beyond repair after a short period of operation.

Chain Scabbard

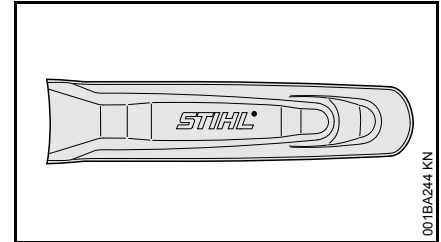

The scope of supply includes a bar scabbard that matches the cutting attachment.

If guide bars of different lengths are mounted to the pole pruner, always use a chain scabbard of the correct length which covers the complete guide bar.

The length of the matching guide bars is marked on the side of the chain scabbard.

Mounting the Bar and Chain

Removing the chain sprocket cover

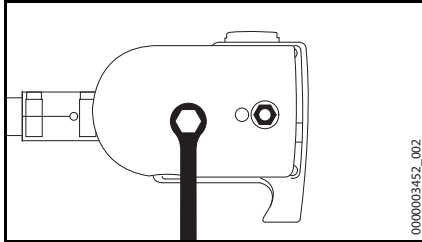

- Unscrew the nut and remove the cover

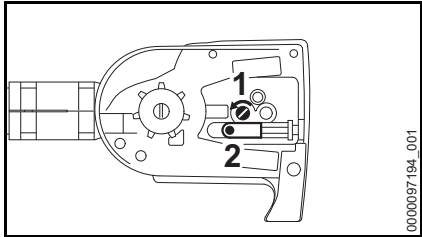

- Turn the screw (1) counterclockwise until the tensioner slide (2) butts against the left end of the housing slot, then back it off 5 full turns

Fitting the saw chain

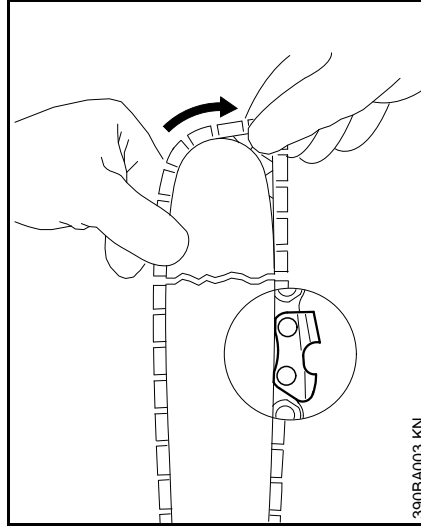

! WARNING

Wear work gloves to protect your hands from the sharp cutters.

- Fit the saw chain – start at the bar nose

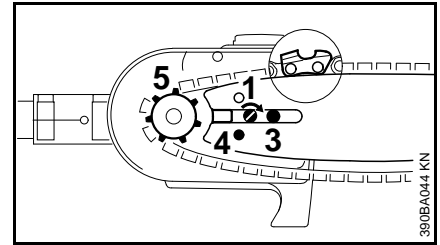

- Fit the guide bar over the screw (3) and engage peg of tensioner slide in the hole (4) – place the saw chain over the chain sprocket (5) at the same time
- Turn the tensioning screw (1) clockwise until there is very little chain sag on the underside of the bar – and the drive link tangs are engaged in the bar groove
- Refit the cover and screw on the nut finger-tight
- Go to chapter on "Tensioning the Saw Chain"

Tensioning the Chain

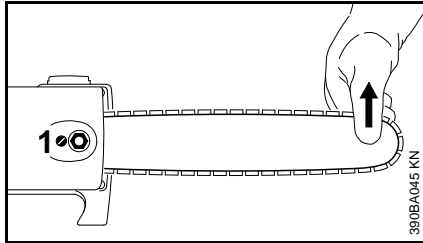

Re-tensioning during cutting work:

- Shut off the engine
- Loosen nuts
- Raise the guide bar at the nose
- Use the screwdriver to turn the screw (1) to the right until the saw chain rests against the underside of the guide bar
- Raise the guide bar further and tighten the nuts securely
- Next step: Continue with "Checking Chain Tension"

A new saw chain has to be re-tensioned more often than one that has been in use for some time.

- Check chain tension frequently – see chapter on "Operating Instructions"

Checking Chain Tension

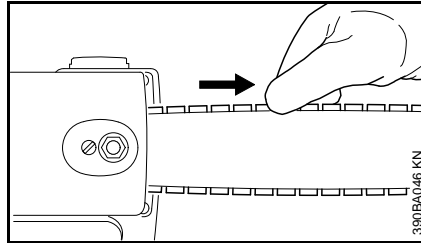

- Shut off the engine
- Wear work gloves to protect your hands
- The saw chain must fit snugly against the underside of the bar and it must still be possible to pull the chain along the guide bar by hand
- If necessary, re-tension the saw chain

A new saw chain has to be re-tensioned more often than one that has been in use for some time.

- Check chain tension frequently – see chapter on "Operating Instructions"

Chain Lubricant

For automatic and reliable lubrication of the chain and guide bar – use only an environmentally compatible quality chain and bar lubricant. Rapidly biodegradable STIHL BioPlus is recommended.



NOTICE

Biological chain oil must be resistant to aging (e.g. STIHL BioPlus), since it will otherwise quickly turn to resin. This results in hard deposits that are difficult to remove, especially in the area of the chain drive and chain. It may even cause the oil pump to seize.

The service life of the chain and guide bar depends on the quality of the lubricant. It is therefore essential to use only a specially formulated chain lubricant.



WARNING

Do not use waste oil. Renewed contact with waste oil can cause skin cancer. Moreover, waste oil is environmentally harmful.



NOTICE

Waste oil does not have the necessary lubricating properties and is unsuitable for chain lubrication.

Filling Chain Oil Tank



NOTICE

A full chain oil tank is sufficient for only half a tankful of fuel. Check the oil level regularly during cutting work. Never allow the oil tank to run dry

Preparations

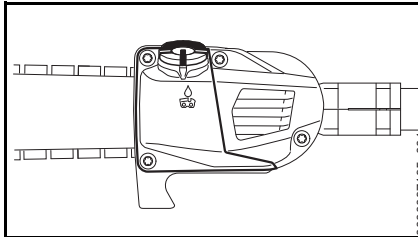

- Thoroughly clean the fuel cap and the area around it to ensure that no dirt falls into the tank
- Position the machine so that the fuel cap is facing upwards

To open:

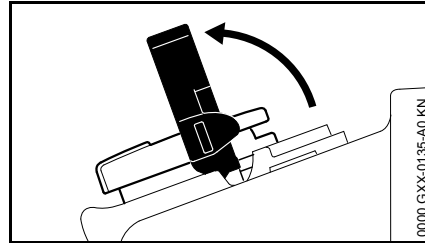

- Open the bracket

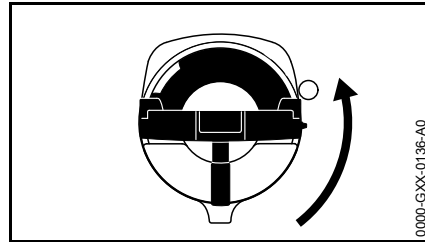

- Twist fuel cap (ca. 1/4 turn)

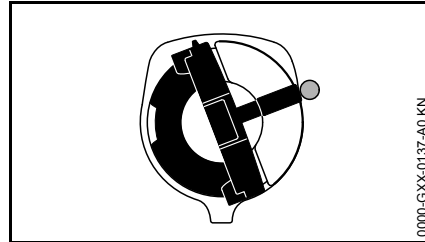

Markings on fuel cap and oil tank must align

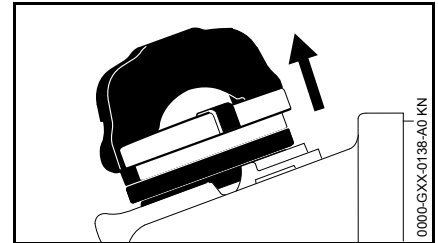

- Remove the fuel cap

Filling up with chain oil

- Fill up with chain oil

Take care not to spill chain oil during refilling and do not overfill the tank.

STIHL recommends use of the STIHL filling system for chain oil (special accessory).

To close:

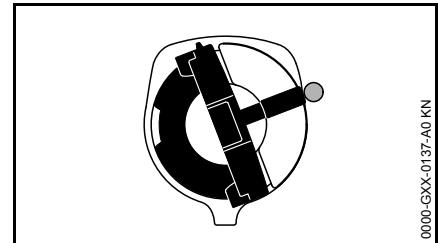

Clip is in an upright position:

- Fit the fuel cap – marks on the fuel cap and oil tank must line up.
- Push the fuel cap down as far as it will go

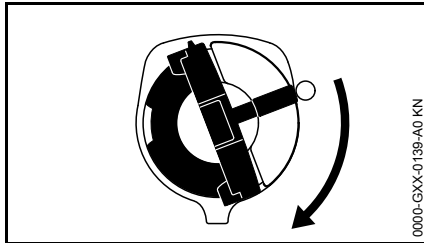

- Hold the fuel cap down and twist it clockwise until it engages

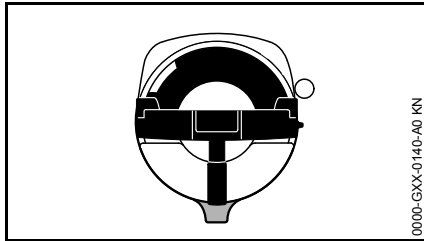

Then the markings on fuel cap and oil tank will align

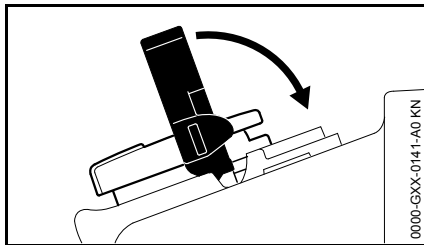

- Close the bracket lock

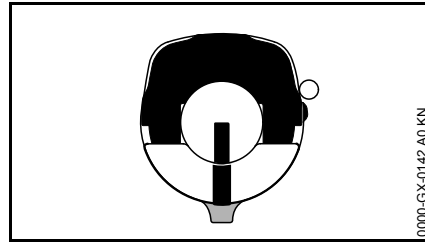

The fuel cap is locked

If the oil level in the tank does not go down, the reason may be a problem in the oil supply system: Check chain lubrication, clean the oilways, contact your dealer for assistance if necessary. STIHL recommends that maintenance and repair work be carried out only by authorised STIHL dealers.

If the fuel cap will not lock onto the oil tank

The base of the fuel cap is tilted in relation to the upper part.

- Remove the fuel cap from the oil tank and look at it from above

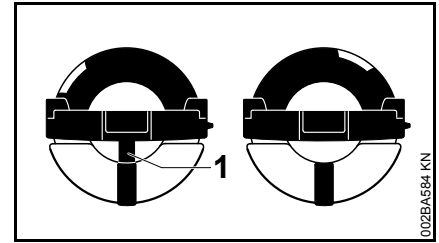

- left: Base of fuel cap is tilted – interior marking (1) is aligned with the exterior marking
- right: Bottom of the fuel cap in correct position – inner mark is under the grip. It does not align with the exterior marking

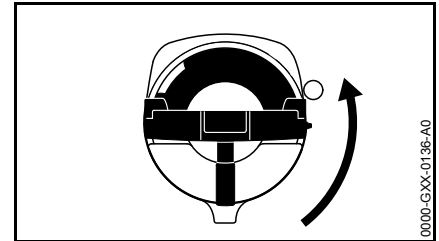

- Fit fuel cap and twist it counterclockwise until it engages in the seat of the filling port
- Continue to twist the fuel cap counterclockwise (approx. 1/4 turn) – this will twist the base of the cap into the correct position
- Twist the fuel cap clockwise and close it – see section "Closing"

Checking Chain Lubrication

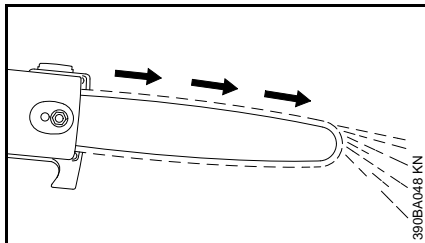

The saw chain must always throw off a small amount of oil.



NOTICE

Never operate without chain lubrication. If the chain runs dry, the whole cutting attachment will be irretrievably damaged within a very short time. Always check chain lubrication and the oil level in the tank before starting work.

Every new chain has to be broken in for about 2 to 3 minutes.

After breaking in the chain, check chain tension and adjust if necessary – see "Checking Chain Tension".

Fitting the Harness

Not all basic power tools are equipped with a shoulder strap and carrying ring.

- Fit the carrying ring – see "Mounting the Attachment".

The shoulder strap is available as a special accessory.

The type of carrying ring, shoulder strap and carabiner depends on the market and the basic power tool.

Shoulder Strap

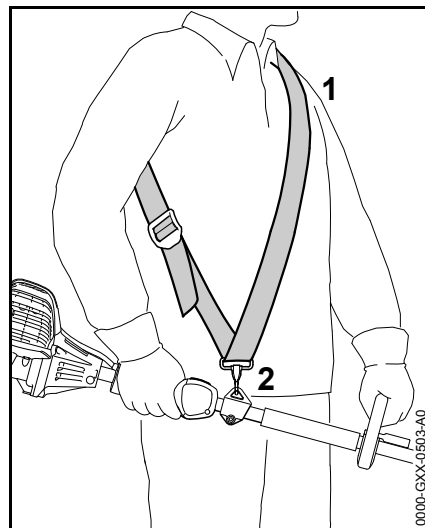

- Put on the shoulder strap (1).
- Adjust the length of the strap – with the machine attached, the carabiner (2) must be about a hand's width below your right hip.

Attaching Machine to Shoulder Strap

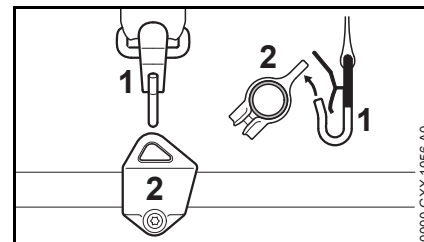

- Attach the carabiner (1) to the carrying ring (2) on the shaft.

Disconnecting Machine from Shoulder Strap

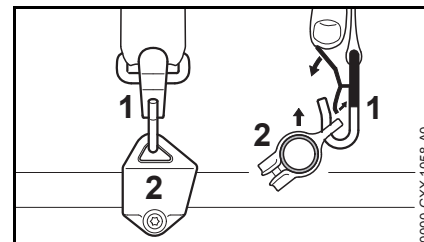

- Press down the bar on the carabiner (1) and pull the carrying ring (2) out of the carabiner.

Throwing Off the Machine

WARNING

The machine must be quickly thrown off in the event of imminent danger. To throw off the machine, use the procedure described under "Disconnecting Machine from Shoulder Strap". Practice removing and putting down the machine as you would in an

emergency. To avoid damage, do not throw the machine to the ground when practicing.

Starting / Stopping the Engine

Starting the Engine

Always follow the operating instructions for the KombiEngine and basic power tool.

- Remove the chain guard.

Check that the chain is not touching the ground or any other obstacles.

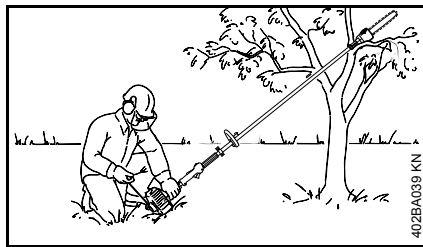

- Position the unit securely for starting: Put the powerhead on the ground so that it rests on the engine support. Rest the hook on the cutting attachment on a raised support, e.g. a mound or branch.
- Make sure you have a firm footing, either standing, stooping or kneeling.
- Hold the machine with your left hand and press it down **firmly** – do not touch the controls on the control handle – see KombiEngine or basic power tool instruction manual.



NOTICE

Do not stand or kneel on the drive tube.

Alternative method of starting

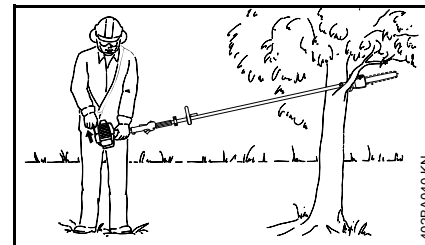

- Hang the cutting attachment on a branch so that it is held by the hook.
- Make sure you have a safe and secure footing.
- Hold the machine with your left hand and press it down firmly – do not touch the controls on the control handle – see KombiEngine or basic power tool instruction manual.

WARNING

The saw chain may begin to run as soon as the engine starts. For this reason, blip the throttle after starting – the engine returns to idling speed.

The starting procedure is now as described in the instruction manual of the KombiEngine or basic power tool you are using.

Stopping the Engine

- See KombiEngine or basic power tool instruction manual.

Operating Instructions

During Operation

Check chain tension frequently

A new chain has to be retensioned more often than one that has been in use for some time.

Chain cold

Tension is correct when the chain fits snugly against the underside of the bar and can still be pulled along the bar by hand. Retension if necessary – see "Tensioning the Saw Chain".

Chain at operating temperature

The chain stretches and begins to sag. The drive links must not come out of the bar groove – the chain may otherwise jump off the bar. Retension the chain – see "Tensioning the Saw Chain".



NOTICE

The chain contracts as it cools down. If it is not slackened off, it can damage the gear shaft and bearings.

After Finishing Work

- Slacken off the chain if you have retensioned it at operating temperature during cutting work.



NOTICE

Always slacken off the chain after finishing work. The chain contracts as it cools down. If it is not slackened off, it can damage the gear shaft and bearings.

Storing for a long period

See chapter on "Storing the Machine"

Taking Care of the Guide Bar

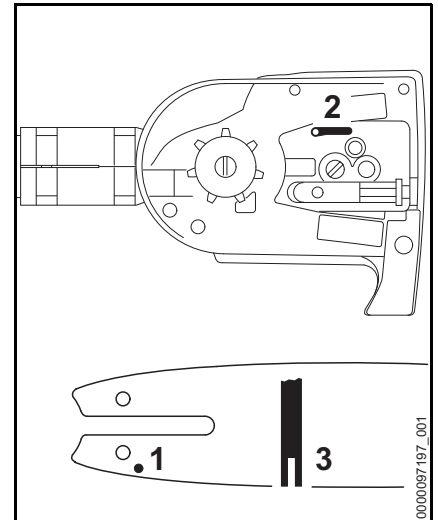

- Turn the bar over – every time you sharpen the chain and every time you replace the chain – this helps avoid one-sided wear, especially at the nose and underside of the bar
- Regularly clean the oil inlet hole (1), the oilway (2) and the bar groove (3)
- Measure the groove depth – with the scale on the filing gauge (special accessory) – in the area used most for cutting

Chain type	Chain pitch	Minimum groove depth
Picco	3/8" P	5.0 mm
Picco	1/4" P	4.0 mm

If groove depth is less than specified:

- Replace the guide bar

The drive link tangs will otherwise scrape along the bottom of the groove – the cutters and tie straps will not ride on the bar rails.

Storing the Machine

For periods of 30 days or longer

- Remove the saw chain and guide bar, clean them and spray with corrosion inhibiting oil.
- If you use a biological chain and bar lubricant, e.g. STIHL BioPlus, completely fill the chain oil tank.
- If the KombiTool is removed from the KombiEngine and stored separately: Fit the protective cap on the drive tube to avoid dirt getting into the coupling.
- Store the machine in a dry, high or locked location – out of the reach of children and other unauthorized persons.

Checking and Replacing the Chain Sprocket

- Remove chain sprocket cover, saw chain and guide bar

Replace the chain sprocket

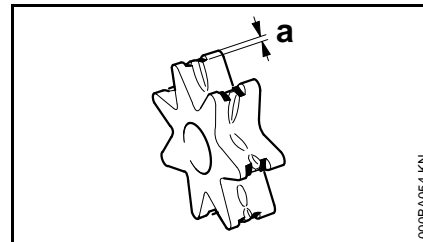

- replace after using two saw chains or sooner
- if the wear marks (a) on the sprocket are deeper than approx. 0.5 mm (0.02 in) since this would reduce the service life of the saw chain. You can use a gauge (special accessory) to check the depth of the wear marks

Using two saw chains in alternation helps preserve the chain sprocket.

STIHL recommends the use of original STIHL chain sprockets.

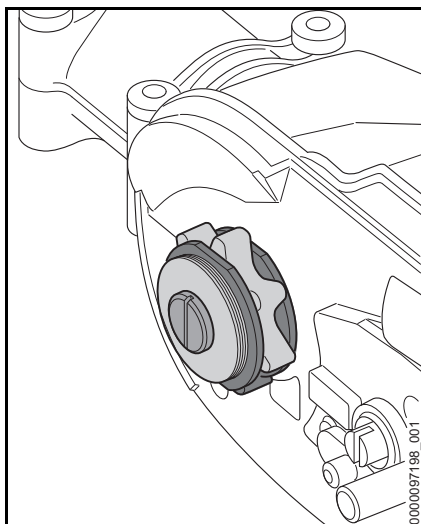

The chain sprocket is driven via a friction clutch. Have the chain sprocket replaced by an authorized dealer.

STIHL recommends that maintenance and repair work be carried out only by authorized STIHL dealers.

Maintaining and Sharpening the Saw Chain

Cutting effortlessly with a correctly sharpened chain

A properly sharpened chain slices through wood effortlessly and requires very little feed pressure.

Do not work with a dull or damaged chain as it will increase the physical effort required, produce unsatisfactory results and a higher rate of wear.

- Clean the chain.
- Check the chain for cracks in the links and damaged rivets.
- Replace any damaged or worn parts of the chain and match the new parts to the shape and size of the original parts.

Carbide-tipped saw chains (Duro) are particularly wear resistant. STIHL recommends you have your chain resharpened by a STIHL servicing dealer.

WARNING

It is absolutely essential to comply with the angles and dimensions specified below. If the saw chain is incorrectly sharpened – and in particular if the depth gauge is set too low – there is an increased risk of kickback, with resulting **risk of injury**.

The saw chain cannot be locked in place on the guide bar. Therefore, it is best to remove the chain from the bar and resharpen it on a workshop sharpening tool (FG 2, HOS, USG).

Chain pitch

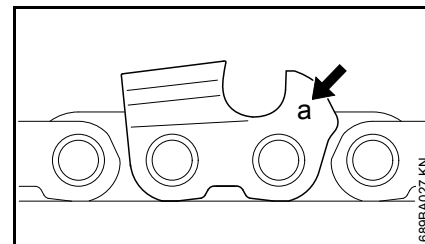

The chain pitch (a) is marked on the depth gauge end of each cutter.

Mark (a)	Chain pitch	
	inch	mm
7	1/4 P	6,35
1 or 1/4	1/4	6,35
6, P or PM	3/8 P	9,32
2 or 325	0.325	8,25
3 or 3/8	3/8	9,32

Select file diameter according to chain pitch – see table “Sharpening Tools”.

You must observe certain angles when resharpening the chain cutter.

Filing and side plate angles

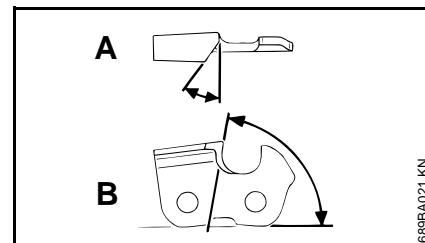

A Filing angle

STIHL saw chains are sharpened to a filing angle of 30°. Exceptions are ripping chains with a filing angle of 10°. Ripping chains have an X in their designations.

B Side plate angle

The correct side plate angle is obtained automatically if you use the prescribed file holder and file diameter.

Cutter shapes	Angle (°)	
	A	B
Micro = semi chisel cutter, e.g. 63 PM3, 26 RM3, 71 PM3	30	75
Super = chisel cutter, e.g. 63 PS3, 26 RS, 36 RS3	30	60
Ripping chain, e.g. 63 PMX, 36 RMX	10	75

The angles must be the same on all cutters. If the angles are uneven: Chain will run roughly, not in a straight line, wear quickly and finally break.

File holder

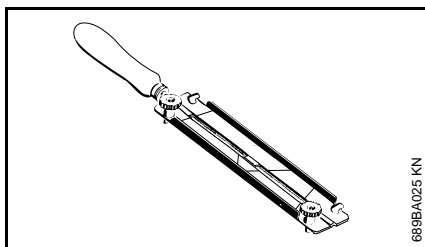

● Use a file holder

A file holder must be used for manual reshaping (see table "Sharpening Tools"). The correct filing angles are marked on the file holder.

Use only special saw chain sharpening files. Other files have the wrong shape and cut.

For checking angles

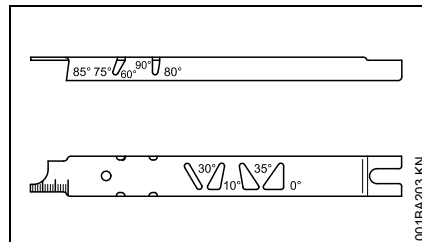

Use a STIHL filing gauge (special accessory, see table "Sharpening Tools"). This is a universal tool for checking the filing and side plate angles, depth gauge setting, cutter length and groove depth. It also cleans the guide bar groove and oil inlet holes.

File correctly

- Select sharpening tools according to chain pitch.
- If you use an FG 2, HOS or USG sharpener: Remove the chain from the bar and sharpen according to the instructions supplied with the tool.
- Clamp the bar in a vise if necessary.
- Sharpen the chain frequently, take away as little metal as possible – two or three strokes of the file are usually enough.

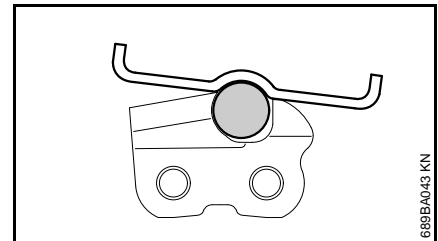
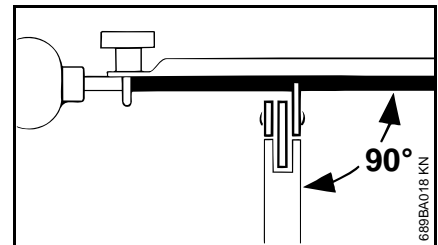

- Hold the file **horizontally** (at a right angle to the side of the guide bar) and file according to the angles marked on the file holder. Rest the file holder on the top plate and depth gauge.
 - Always file from the inside to the outside of the cutter.
 - The file only sharpens on the forward stroke – lift the file off the cutter on the backstroke.
 - Avoid touching the tie straps and drive links with the file.
 - Rotate the file at regular intervals while filing to avoid one-sided wear.
 - Use a piece of hardwood to remove burrs from the cutting edge.
 - Check angles with the filing gauge.
- All cutters must be the same length.

If the cutters are not the same length, they will have different heights. This makes the chain run roughly and can cause it to break.

- Find the shortest cutter and then file all other cutters back to the same length. It is best to have this work done by a servicing dealer on an electric grinder.

Depth gauge setting

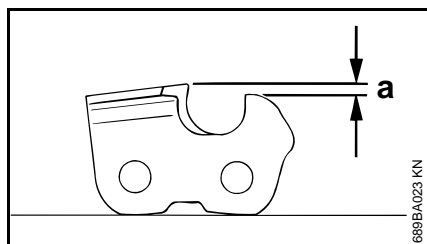

The depth gauge determines the height at which the cutter enters the wood and thus the thickness of the chip removed.

- a** Specified distance or setting between depth gauge and cutting edge.

This setting may be increased by 0.2 mm (0.008") for cutting softwood in the mild weather season – no frost.

Chain pitch		Depth gauge Setting (a)	
inch	(mm)	mm	(inch)
1/4 P	(6,35)	0,45	(0.018)
1/4	(6,35)	0,65	(0.026)
3/8 P	(9,32)	0,65	(0.026)
0.325	(8,25)	0,65	(0.026)
3/8	(9,32)	0,65	(0.026)

Lowering depth gauges

The depth gauge setting is reduced when the chain is sharpened.

- Use a filing gauge to check the setting every time you sharpen the chain.

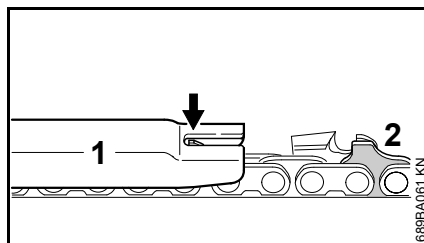

- Place a filing gauge (1) that matches the chain pitch on the chain and press it against the cutter – if the depth gauge projects from the filing gauge, the depth gauge has to be lowered.

Saw chains with humped drive link (2) – upper part of humped drive link (2) (with service mark) is lowered along with the depth gauge.

! WARNING

The other parts of the humped drive link must not be filed since this may increase the kickback tendency of the power tool.

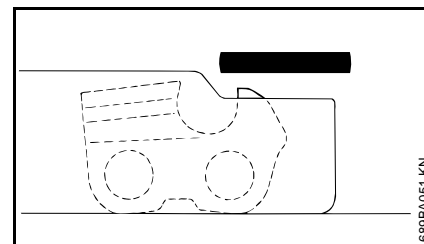

- File down the depth gauge until it is level with the filing gauge.

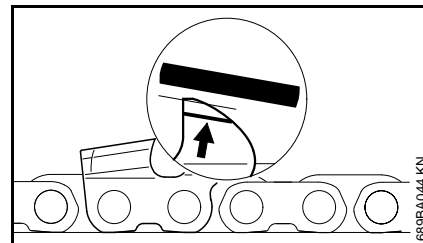

- File the top of the depth gauge parallel to the stamped service marking (see arrow) – but do not lower the highest point of the depth gauge in this process.

! WARNING

The kickback tendency of the machine is increased if the depth gauges are too low.

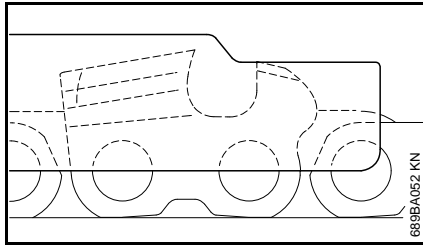

- After sharpening, clean the chain thoroughly, remove filings or grinding dust – lubricate the chain thoroughly.
- Before a long out-of-service period, clean the chain and store it in a well-oiled condition.
- Place the filing gauge on the chain – the highest point of the depth gauge must be level with the filing gauge.

Sharpening Tools (special accessories)

Chain pitch	Round file Ø	Round file	File holder	Filing gauge	Flat file	Sharpening kit ¹⁾	
inch	(mm)	mm (inch)	Part No.	Part No.	Part No.	Part No.	
1/4 P	(6,35)	3,2 (1/8)	5605 771 3206	5605 750 4300	0000 893 4005	0814 252 3356	5605 007 1000
1/4	(6,35)	4,0 (5/32)	5605 772 4006	5605 750 4327	1110 893 4000	0814 252 3356	5605 007 1027
3/8 P	(9,32)	4,0 (5/32)	5605 772 4006	5605 750 4327	1110 893 4000	0814 252 3356	5605 007 1027
0.325	(8,25)	4,8 (3/16)	5605 772 4806	5605 750 4328	1110 893 4000	0814 252 3356	5605 007 1028
3/8	(9,32)	5,2 (13/64)	5605 772 5206	5605 750 4329	1110 893 4000	0814 252 3356	5605 007 1029

¹⁾ consisting of file holder with round file, flat file and filing gauge

Maintenance and Care

The following intervals apply for normal operating conditions. If your daily working time is longer or operating conditions are difficult (very dusty work area, resin-rich wood, tropical wood, etc.), shorten the specified intervals accordingly. If you only use the tool occasionally, extend the intervals accordingly.		before starting work	after finishing work or daily	after each refueling stop	weekly	monthly	every 12 months	if problem	if damaged	as required
All accessible screws and nuts (not adjusting screws)	Re-tighten									X
Chain lubrication	Check	X								
Saw chain	Inspect, also check sharpness	X		X						
	Check chain tension.	X		X						
	Sharpen									X
Guide bar	Check (wear, damage)	X								
	Clean and turn over				X			X		
	Deburr				X					
	Replace								X	X
Chain Sprocket	Check				X					
	Have replaced by servicing dealer ¹⁾									X
Safety labels	Replace								X	

¹⁾ STIHL recommends an authorized STIHL servicing dealer.

Minimize Wear and Avoid Damage

Observing the instructions in this manual and the KombiEngine manual helps reduce the risk of unnecessary wear and damage to the power tool.

The power tool must be operated, maintained and stored with the due care and attention described in these instruction manuals.

The user is responsible for all damage caused by non-observance of the safety precautions, operating and maintenance instructions. This includes in particular:

- Alterations or modifications to the product not approved by STIHL.
- Using tools or accessories which are neither approved or suitable for the product or are of a poor quality.
- Using the product for purposes for which it was not designed.
- Using the product for sports or competitive events.
- Consequential damage caused by continuing to use the product with defective components.

Maintenance Work

All the operations described in the chapter on "Maintenance and Care" must be performed on a regular basis. If these maintenance operations cannot be performed by the owner, they should be performed by a servicing dealer.

STIHL recommends that you have servicing and repair work carried out exclusively by an authorized STIHL

servicing dealer. STIHL dealers are regularly given the opportunity to attend training courses and are supplied with the necessary technical information.

If these maintenance operations are not carried out as specified, the user assumes responsibility for any damage that may occur. Among other parts, this includes:

- Corrosion and other consequential damage resulting from improper storage.
- Damage to the product resulting from the use of poor quality replacement parts.

Parts Subject to Wear and Tear

Some parts of the power tool are subject to normal wear and tear even during regular operation in accordance with instructions and, depending on the type and duration of use, have to be replaced in good time. Among other things, this includes:

- Saw chain, guide bar
- Chain sprocket
- Friction clutch
- Chain tensioner

Main Parts

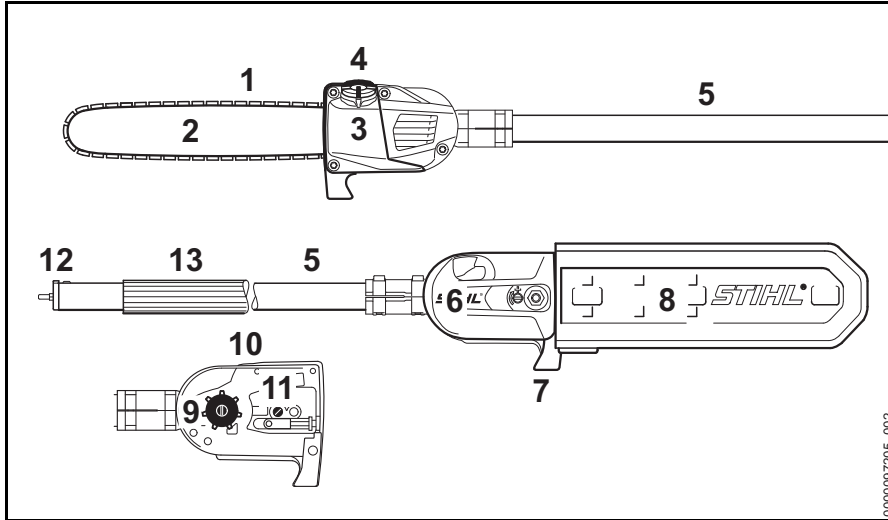

- 1 Saw chain
- 2 Guide bar
- 3 Oil tank
- 4 Oil tank cap
- 5 Shaft
- 6 Chain sprocket cover
- 7 Hook
- 8 Chain scabbard
- 9 Chain sprocket
- 10 Gauge bar
- 11 Chain tensioner
- 12 Sleeve
- 13 Handle hose

Specifications

Chain lubrication

Fully automatic, speed-controlled oil pump with rotary piston

Oil tank capacity: 220 cm³ (0.22 l)

Weight

Cutting attachment
3/8" P with drive
tube: 2.1 kg

Cutting attachment
1/4" P with drive
tube: 2.0 kg

Cutting attachment

The actual cutting length may be less than the specified cutting length.

Guide bar Rollo Light 01

Blade length: 25, 30, 35 cm
Pitch: 3/8" P (9.32 mm)
Groove width: 1.1 mm

Guide bar Rollo Light 01

Blade length: 25, 30, 35 cm
Pitch: 1/4" P (6.35 mm)
Groove width: 1.1 mm

Saw chain 3/8" P

Picco Micro Mini 3 (61 PMM3)
Type 3610

Pitch: 3/8" P (9.32 mm)
Drive link gauge: 1.1 mm

Saw chain 1/4" P

Picco Micro3 (71PM3) Type 3670

Pitch: 1/4" P (6.35 mm)
Drive link gauge: 1.1 mm

Chain sprocket

7-tooth for 3/8" P

8-tooth for 1/4" P

Sound and Vibration Levels

Noise and vibration data measurements on power tools with the HT-KM KombiTool include idling and rated maximum speed with the same duration of exposure.

For further details on compliance with Vibration Directive 2002/44/EC, see

www.stihl.com/vib

Sound pressure level L_{peq} in accordance with ISO 22868

KM 56 R	90 dB(A)
KM 85 R	92 dB(A)
KM 94 R:	91 dB(A)
KM 111 R:	93 dB(A)
KM 131 R:	92 dB(A)
FR 131 T:	98 dB(A)
KMA 130 R:	90 dB(A)
KMA 135 R:	84 dB(A)

Sound power level L_w in accordance with ISO 22868

KM 56 R	106 dB(A)
KM 85 R	109 dB(A)
KM 94 R:	107 dB(A)
KM 111 R:	108 dB(A)
KM 131 R:	109 dB(A)
FR 131 T:	109 dB(A)
KMA 130 R:	100 dB(A)
KMA 135 R:	94 dB(A)

Vibration level $a_{hv,eq}$ in accordance with ISO 22867

	Handle, left	Handle, right
KM 56 R	6.8 m/s ²	4.8 m/s ²
KM 85 R	4.7 m/s ²	5.2 m/s ²
KM 94 R:	4.0 m/s ²	4.7 m/s ²
KM 111 R:	3.9 m/s ²	3.4 m/s ²
KM 131 R:	4.8 m/s ²	4.0 m/s ²
FR 131 T:	2.7 m/s ²	1.7 m/s ²
KMA 130 R	2.5 m/s ²	2.2 m/s ²
KMA 135 R	2.5 m/s ²	2.0 m/s ²

The K-factor in accordance with Directive 2006/42/EC is 2.0 dB(A) for the sound pressure level and sound power level; the K-factor in accordance with Directive 2006/42/EC is 2.0 m/s² for the vibration level.

REACH

REACH is an EC regulation and stands for the Registration, Evaluation, Authorization and Restriction of Chemical substances.

For information on compliance with the REACH regulation (EC) No. 1907/2006 see

www.stihl.com/reach

Maintenance and Repairs

Users of this machine may only carry out the maintenance and service work described in this user manual. All other repairs must be carried out by a servicing dealer.

STIHL recommends that you have servicing and repair work carried out exclusively by an authorized STIHL servicing dealer. STIHL dealers are regularly given the opportunity to attend training courses and are supplied with the necessary technical information.

When repairing the machine, only use replacement parts which have been approved by STIHL for this power tool or are technically identical. Only use high-quality replacement parts in order to avoid the risk of accidents and damage to the machine.

STIHL recommends the use of original STIHL replacement parts.

Original STIHL parts can be identified by the STIHL part number, the **STIHL** logo and the STIHL parts symbol  (the symbol may appear alone on small parts).

Disposal

Contact the local authorities or your STIHL servicing dealer for information on disposal.

Improper disposal can be harmful to health and pollute the environment.

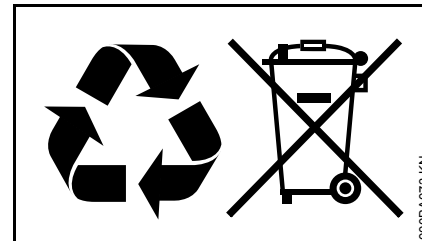

- Take STIHL products including packaging to a suitable collection point for recycling in accordance with local regulations.
- Do not dispose with domestic waste.

EC Declaration of Conformity

ANDREAS STIHL AG & Co. KG
Badstr. 115
D-71336 Waiblingen
Germany

declare under our sole responsibility that

Designation: KombiTool Pole
Pruner
Make: STIHL
Series: HT-KM
Serial identification
number: 4182

conforms to the relevant provisions of
Directive 2006/42/EC and has been
developed and manufactured in
compliance with the following standards
in the versions valid on the date of
production:

EN ISO 12100, EN ISO 11680-1 (in
conjunction with the specified KM
models).

EN ISO 12100, EN 60745-1, EN 60745-
2-13 (in conjunction with KMA 130 R)

EN ISO 12100, EN 62841-1, EN 62841-
4-1, ISO 11680-1 (in conjunction with
KMA 135 R)

EN ISO 12100, EN ISO 11680-2 (in
conjunction with the specified FR
models).

EC Type Examination

The EC type examination was carried
out by

for HT-KM with KM 56 R, KM 94 R at:
DPLF Deutsche Prüf- und
Zertifizierungsstelle für Land- und
Forsttechnik
(NB 0363)
Spremlinger Str. 1
D-64823 Groß-Umstadt

	Certification No.
HT-KM with KM 56 R:	D-EG 16.00573/01
HT-KM with KM 94 R:	D-EG 16.00574/01

HT-KM with KM 111 R, KM 131 R, FR 131 T

TÜV Süd Product Service GmbH
(NB 0123)
Ridlerstrasse 65
D-80339 München

	Certification No.
HT-KM with KM 111 R:	M6A 18 03 10127 508
HT-KM with KM 131 R:	M6A 18 03 10127 508
HT-KM with FR 131 T:	M6A 17 12 10127 500

HT-KM with KMA'

VDE Prüf- u. Zertifizierungsinstitut
(NB 0366)
Merianstraße 28
D-63069 Offenbach

	Certification No.
HT-KM with KMA 130 R:	40047718
HT-KM with KMA 135 R:	40051625

Technical documents deposited at:

ANDREAS STIHL AG & Co. KG
Produktzulassung

The year of manufacture is specified on
the power tool.

Waiblingen, 2022-01-14

ANDREAS STIHL AG & Co. KG
pp



Dr. Jürgen Hoffmann

Director Product Certification &
Regulatory Affairs



UKCA Declaration of Conformity

ANDREAS STIHL AG & Co. KG
Badstr. 115
D-71336 Waiblingen

Germany

declares under our sole responsibility that

Designation: KombiTool Pole Pruner

Make: STIHL

Series: HT-KM

Serial identification number: 4182

conforms to the relevant provisions of the UK Supply of Machinery (Safety) Regulations 2008 and has been manufactured in compliance with the following standards in the versions valid on the date of production:

EN ISO 12100, EN ISO 11680-1 (in conjunction with the specified KM models).

EN ISO 12100, EN 60745-1, EN 60745-2-13 (in conjunction with KMA 130 R)

EN ISO 12100, EN 62841-1, EN 62841-4-1, ISO 11680-1 (in conjunction with KMA 135 R)

EN ISO 12100, EN ISO 11680-2 (in conjunction with the specified FR models)

Type Examination

The type examination was carried out by

HT-KM with KM 56 R, KM 94 R, KM 111 R, KM 131 R, FR 131 T

Intertek Testing & Certification Ltd,
Academy Place, 1 – 9 Brook Street,
Brentwood Essex, CM14 5NQ, United Kingdom

Certification No.

HT-KM with KM 56 R: ITS UK MCR 31

HT-KM with KM 94 R: ITS UK MCR 32

HT-KM with KM 111 R: ITS UK MCR 74

HT-KM with KM 131 R: ITS UK MCR 74

HT-KM with FR 131 T: ITS UK MCR 72

HT-KM with KMA

Intertek Testing & Certification Ltd,
Academy Place, 1 – 9 Brook Street,
Brentwood Essex, CM14 5NQ, United Kingdom

Certification No.

HT-KM with KMA 130 R: ITS UK MCR 40

HT-KM with KMA 135 R: ITS UK MCR 41

Technical documents deposited at:

ANDREAS STIHL AG & Co. KG

The year of manufacture is indicated on the power tool.

Waiblingen, 2022-03-31

ANDREAS STIHL AG & Co. KG

pp



Dr. Jürgen Hoffmann

Director Product Certification & Regulatory Affairs



0458-473-0121-D

englisch



www.stihl.com



0458-473-0121-D