

HIKOKI

电镐

Demolition Hammer

H 65SB3

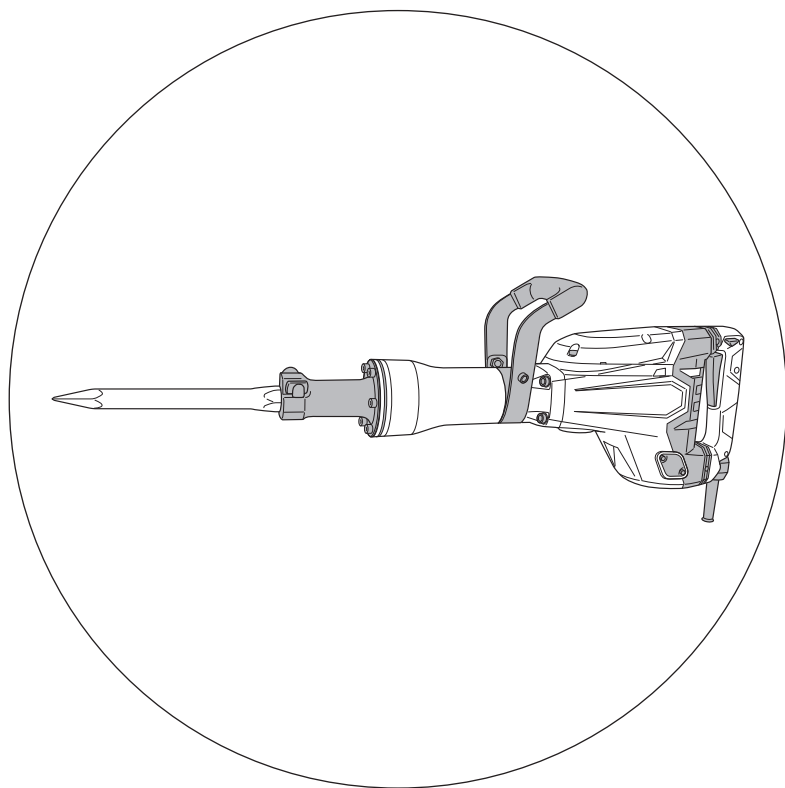

保留备用

Keep for future reference



使用说明书

Handling instructions



目次

电动工具通用安全警告	2	用途.....	6
电镐安全警告.....	4	作业之前.....	7
附加安全警告.....	4	如何使用电镐.....	7
符号.....	5	更换润滑油.....	8
规格.....	5	维护和检查.....	9
标准附件.....	5	维修零部件一览表.....	10
选购附件（分开销售）.....	6		

电动工具通用安全警告

警告！

阅读所有警告和所有说明。

不遵照以下警告和说明会导致电击、着火和 / 或严重伤害。

保存所有警告和说明书以备查阅。

在所有下列的警告中术语“电动工具”指市电驱动(有线)电动工具或电池驱动(无线)电动工具。

1) 工作场地的安全

a) 保持工作场地清洁和明亮。

混乱和黑暗的场地会引发事故。

b) 不要在易爆环境，如有易燃液体、气体或粉尘的环境下操作电动工具。

电动工具产生的火花会点燃粉尘或气体。

c) 让儿童和旁观者离开后操作电动工具。

注意力不集中会使操作者失去对工具的控制。

2) 电气安全

a) 电动工具插头必须与插座相配。绝不能以任何方式改装插头。需接地的电动工具不能使用任何转换插头。

未经改装的插头和相配的插座将减少电击危险。

b) 避免人体接触接地表面，如管道、散热片和冰箱。

如果你身体接地会增加电击危险。

c) 不得将电动工具暴露在雨中或潮湿环境中。

水进入电动工具将增加电击危险。

d) 不得滥用电线。绝不能用电线搬运、拉动电动工具或拔出其插头。使电线远离热源、油、锐边或运动部件。

受损或缠绕的软线会增加电击危险。

- e) 当在户外使用电动工具时，使用适合户外使用的外接软线。
适合户外使用的软线将减少电击危险。
- f) 如果在潮湿环境下操作电动工具是不可避免的，应使用剩余电流动作保护器（RCD）。
使用RCD可减小电击危险。

3) 人身安全

- a) 保持警觉，当操作电动工具时关注所从事的操作并保持清醒。当你感到疲倦，或在有药物、酒精或治疗反应时，不要操作电动工具。
在操作电动工具时瞬间的疏忽会导致严重人身伤害。
- b) 使用个人防护装置。始终佩戴护目镜。
安全装置，诸如适当条件下使用防尘面具、防滑安全鞋、安全帽、听力防护等装置能减少人身伤害。
- c) 防止意外起动。确保开关在连接电源和 / 或电池盒、拿起或搬运工具时处于关断位置。
手指放在已接通电源的开关上或开关处于接通时插入插头可能会导致危险。
- d) 在电动工具接通之前，拿掉所有调节钥匙或扳手。
遗留在电动工具旋转零件上的扳手或钥匙会导致人身伤害。
- e) 手不要伸展得太长。时刻注意立足点和身体平衡。
这样在意外情况下能很好地控制电动工具。
- f) 着装适当。不要穿宽松衣服或佩戴饰品。让衣服、手套和头发远离运动部件。
宽松衣服、佩饰或长发可能会卷入运动部件中。
- g) 如果提供了与排屑、集尘设备连接用的装置，要确保它们连接完好且使用得当。
使用这些装置可减少尘屑引起的危险。

4) 电动工具使用和注意事项

- a) 不要滥用电动工具，根据用途使用适当的电动工具。
选用适当设计的电动工具会使你工作更有效、更安全。
- b) 如果开关不能接通或关断工具电源，则不能使用该电动工具。
不能用开关来控制的电动工具是危险的且必须进行修理。
- c) 在进行任何调节、更换附件或贮存电动工具之前，必须从电源上拔掉插头和 / 或使电池盒与工具脱开。
这种防护性措施将减少工具意外起动的危险。
- d) 将闲置不用的电动工具贮存在儿童所及范围之外，并且不要让不熟悉电动工具或对这些说明不了解的人操作电动工具。
电动工具在未经培训的用户手中是危险的。

中文

- e) 保养电动工具。检查运动件是否调整到位或卡住，检查零件破损情况和影响电动工具运行的其他状况。如有损坏，电动工具应在使用前修理好。许多事故由维护不良的电动工具引发。
- f) 保持切削刀具锋利和清洁。
保养良好的有锋利切削刃的刀具不易卡住而且容易控制。
- g) 按照使用说明书，考虑作业条件和进行的作业来使用电动工具、附件和工具的刀头等。
将电动工具用于那些与其用途不符的操作可能会导致危险。

5) 维修

- a) 将你的电动工具送交专业维修人员，使用同样的备件进行修理。
这样将确保所维修的电动工具的安全性。

注意！

不可让儿童和体弱人士靠近工作场所。

应将不使用的工具存放在儿童和体弱人士接触不到的地方。

电镐安全警告

- 1. 戴好耳罩。
暴露在噪声中会引起听力损伤。
- 2. 请使用随工具所提供之辅助握把，以免失控而造成人员受伤。
- 3. 在切削附件可能触及暗线或其自身软线之处进行操作时，要通过绝缘握持面来握持工具。
切削附件碰到带电导线会使工具外露的金属零件带电从而使操作者受到电击。

附加安全警告

- 1. 确认所使用的电源与产品铭牌上标示的功率要求相符。
- 2. 确认电源开关已切断。
若电源开关接通，则插头插入电源插座时电动工具将出其不意地立刻转动，从而导致严重事故。
- 3. 当工作区域距离电源较远时，使用足够厚度和额定功率的延伸线缆。延伸线缆应尽可能短。
- 4. RCD
推荐始终使用额定剩余电流不超过为 30mA 的剩余电流动作保护器。
- 5. 作业之后的钻头仍处在高热状态下，切不可摸触，以免灼伤。
- 6. 对墙壁、天花板和地板进行钻孔或钻碎作业时，应彻底查明里面是否敷设电缆或导管。
- 7. 脸部朝上作业时，要带上防护面罩。
- 8. 钻头夹持器应妥予安装。

9. 开始作业时，要先确认油脂是否正常供应，螺钉类是否妥予扭紧。
10. 在高空作业时，应充分注意下面的东西和行人安全。
11. 穿上保护靴，以保护脚。

符号

警告！

如下所示的符号用于本机。使用前请务必理解其含意。

	为降低伤害风险，用户必须阅读 使用说明书		II类工具
--	-------------------------	---	-------

规格

电压	220 V ~	满载冲击率	1400 /min
输入功率	1340 W	重量	18.0 kg

标准附件

除了主机（1台）外，产品包中还包括表中所列的附件。

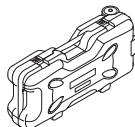
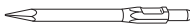
箱子 代码号：339664		1
尖钻头 代码号：944961		1

选购附件（分开销售）

○ 破碎



(1) 尖钻头

总长： 410 mm

代码号： 944961

○ 沥青刮刀

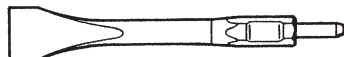

(1) 刀具

总长： 410 mm

宽： 75 mm

代码号： 944964

○ 开槽和饰边

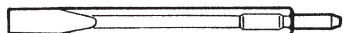

(1) 冷钻

总长： 410 mm

代码号： 944962

○ 铲子

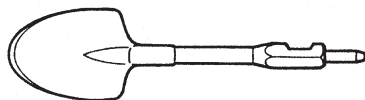

(1) 铲子

总长： 380 mm

代码号： 957154

○ 夯具

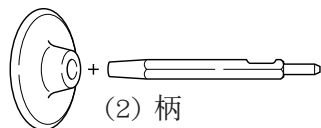

(2) 柄

总长： 250 mm

代码号： 944966

(1) 撞锤

外径： 200 mm

代码号： 944965

○ 六角杆扳手

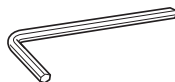

6 MM： 代码号： 872422

3 MM： 代码号： 943277

○ 润滑油

500 g (罐装) 代码号： 980927

30 g (管装) 代码号： 981840

○ 炭刷

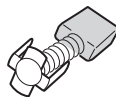

代码号： 999086

用途

混凝土破碎、混凝土切削、开槽、棒切割。

应用例：

装配管道、敷设线缆、卫生设备安装、机械安装、给排水设施建设、室内装修、港口设施建设、其它土木工程施工。

作业之前

1. 电源

确认所使用的电源与工具铭牌上标示的规格是否相符。

2. 电源开关

确认电源开关是否切断。若电源开关接通，则插头插入电源插座时电动工具将出其不意地立刻转动，从而招致严重事故。

3. 延伸电缆

若作业场所移到离开电源的地点，应使用容易足够、铠装合适的延伸线缆，并且要尽可能地短些。

4. 安装工具

注：

像尖钻头及冷凿等工具只能使用HiKOKI的产品。

(1) 擦净后再给工具柄涂上润滑油或机油（图 1）。

(2) 边将停止杆朝前拉，边将其向右转 180°，然后将尖端工具插入前盖上的六角孔内。（图 1）

如果工具的整个凹口部分没有完全插入前盖的端面，使用锤子或其他物体轻轻敲动工具，使其插入。

(3) 把停止杆朝相反方向转动半转，夹紧工具。（图 2）



图 1



图 2

如何使用电镐

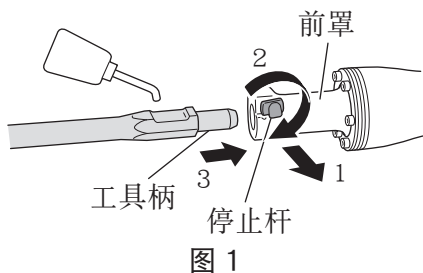
1. 开关操作

拉出时接通开关，松开时切断开关。

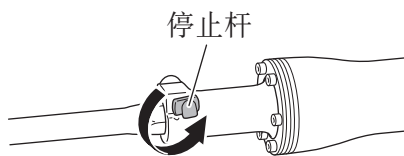
完全拉出开关时，如果将按钮推至“A”，开关将锁定并保持接通状态，即使手指松开开关，也可以继续操作。（图 3）

若要解除锁定，将按钮推至“B”。（图 4）

2. 将钻头移至加工位置后，拉动启动开关。有时，需要用力将钻头紧紧顶住加工位置以便开始钻凿。

这并不是因电镐的故障所致。这说明防止空撞击的安全防护机构已启动。



图 3



图 4

中文

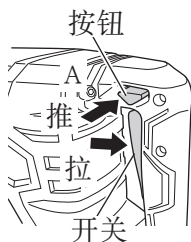
3. 在使用电镐时，请利用其自身的重量进行钻凿。
因为即使将电镐用力按在工作面上并用力推动，作业效果也不会太好。请仅用足以抵销反作用力的力气来抓住电镐即可（图 5）。

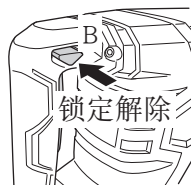

图 5

更换润滑油

该机具有全气密结构以防尘和润滑油漏失。因此该机可以长期不注油运转。更换润滑油方法如下：

润滑油更换周期

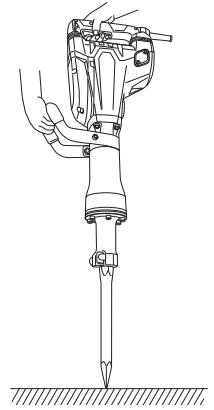
在购人后每用了六个月应更换润滑油。请到最近的指定的HiKOKI代理店更换润滑油。

维护和检查

注意！

确认开关已断开并且从电源插座中拔去电源插头以避免严重事故。

1. 工具检修

当使用变钝的工具时会降低效率并可能使电动机出现故障，因此刚一发现就立即磨快或更换该工具。

2. 检查安装螺钉

要经常检查安装螺钉是否紧固妥善。若发现螺钉松了，应立即重新扭紧，否则会导致严重的事故。

3. 电动机的维护

电动机绕线是电动工具的“心脏部”。应仔细检查有无损伤，是否被油液或水沾湿。

4. 检查炭刷（图 6）

电动机里的炭刷是一种消耗品。炭刷一旦使用到磨损极限，电动机就会出现各种障碍；如果所使用的炭刷是“自停式”，电动机将自动地停止转动。遇到上述情况，应立即换上与图上代号一致的新炭刷。此外，炭刷应经常保持干净状态，以保证能在刷握里自由滑动。



图 6

5. 更换步骤

松开炭刷盖罩的螺丝（六角形插口头螺栓 M4 × 8），然后取下盖罩（图 7）。拆下炭刷盖后便可取下炭刷。更换炭刷后，要拧紧炭刷盖，然后再牢牢地安上炭刷盖罩。

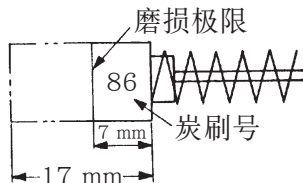
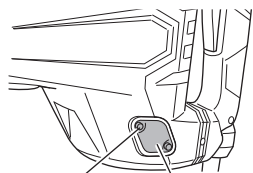

六角形插口头 盖罩
螺栓 M4 × 8

6. 维修零部件一览表

图 7

注意！

HiKOKI牌电动工具的维修、改造和检查须由经HiKOKI公司授权的维修中心进行。

当要求维修或其他保养服务时，若将此零部件一览表与电动工具一起呈交给经HiKOKI公司授权的维修中心，将有助于维修或保养工作。

在操作和维修电动工具时，必须遵守贵国制定的安全的有关规则和标准。

维修零部件一览表

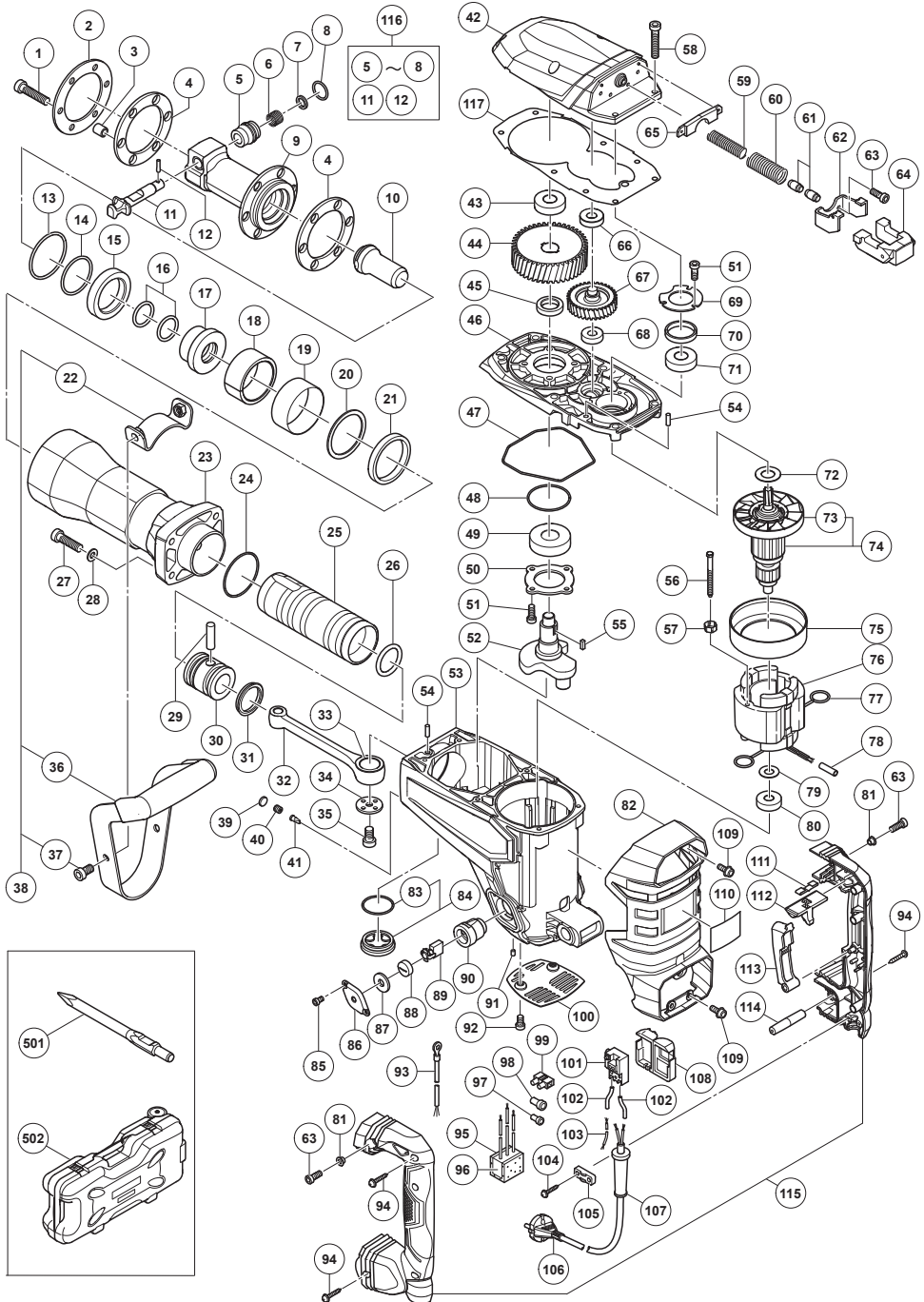

项目号	零件名称	数量
1	尼龙锁紧内六角螺栓 M8×40	6
2	避震板	1
3	螺塞	6
4	前避震器	2
5	弹簧盒	1
6	杠杆弹簧	1
7	避震器 (B)	1
8	圈环	1
9	前盖	1
10	第二锤头	1
11	停止杆	1
12	针辊	1
13	O 型环 (C)	1
14	O 型环 (B)	1
15	避震器 (A)	1
16	O 型环	2
17	轴套	1
18	接口	1
19	接口盖	1
20	接口垫圈 (A)	1
21	聚氨酯环 (A)	1
22	把手固定部件 (带螺母)	1
23	汽缸箱	1
24	O 型环 (1AS-60)	1
25	击块	1
26	O 型环 (A)	1
27	尼龙锁紧内六角螺栓 M8×40	4
28	螺栓垫圈 M8 (黑色)	4
29	柱塞销	1
30	柱塞	1
31	油封 (A)	1
32	连杆总成	1
33	滚针轴承 (NTN 8E-NK 18/20 RDO)	1
34	曲柄垫圈	1

项目号	零件名称	数量
35	密封内六角螺栓 M8×16	1
36	夹卡	1
37	尼龙锁紧内六角螺栓 M8×16	2
38	侧柄总成	1
39	毡垫 (B)	1
40	有帽螺丝	1
41	阀	1
42	齿轮盖	1
43	滚珠轴承 6302VVCMP52L	1
44	主传动齿轮	1
45	间隔环 (B)	1
46	内盖	1
47	密封圈	1
48	O 型环	1
49	滚珠轴承 6205DDCMP52L	1
50	轴承盖	1
51	密封内六角螺栓 M5×16	7
52	曲柄轴	1
53	外罩总成	1
54	定位销 D5×15.8	2
55	导向键 4×4×12	1
56	六角自攻螺丝 D5×65	2
57	专用垫圈	2
58	密封内六角螺栓 M6×40	6
59	把手弹簧 (B)	1
60	把手弹簧 (A)	1
61	把手避震器	2
62	把手导架	1
63	密封内六角螺栓 M5×16	4
64	把手砝码	1
65	把手止动片	1
66	滚珠轴承 6201VV	1
67	反转齿轮	1
68	滚珠轴承 6001VV	1

中文

项目号	零件名称	数量
69	轴承盖 (A)	1
70	间隔环 (A)	1
71	滚珠轴承 6203DDCMPS2L	1
72	轴承垫圈	1
73	风扇	1
74	电枢总成 220V-230V	1
75	风扇导架	1
76	定子总成 220V-230V	1
77	刷端	2
78	乙烯管 L55	1
79	轴承垫圈	1
80	滚珠轴承 6201DDCMPS2L	1
81	间隔块 (B)	2
82	后盖	1
83	O 型环 (S-38)	1
84	油帽总成	1
85	密封内六角螺栓 M4×8	4
86	帽盖	2
87	橡胶帽	2
88	炭刷帽	2
89	炭刷 (自停式) (1 副)	2
90	刷架	2
91	内六角固定螺丝 M5×8	2
92	密封内六角螺栓 M5×12	2
93	内部电线	1
94	自攻螺丝 (附法兰) D4×25 (黑色)	5
95	支架 (B)	1
96	噪声抑制器	1
97	连接器 50091 (10 件)	1
98	连接器 50092 (10 件)	1
99	柱式终端	1
100	尾盖	1
101	开关	1

项目号	零件名称	数量
102	乙烯管 (A) (I.D.7×T0.5×50)	2
103	内部电线 (黑色)	1
104	自攻螺丝 (附法兰) D4×16	2
105	线夹	1
106	电线	1
107	线保护壳 D10.7	1
108	支架	1
109	尼龙锁紧螺丝 (附法兰) M5	4
110	铭牌	1
111	片弹簧	1
112	推钮	1
113	切换杆	1
114	把手轴	1
115	把手 (A).(B) 座	1
116	停止杆总成	1
117	密封包装	1
501	尖钻头 410MM	1
502	箱子 (塑料)	1

CONTENTS

GENERAL POWER TOOL SAFETY WARNINGS	13
DEMOLITION HAMMER SAFETY WARNINGS	15
ADDITIONAL SAFETY WARNINGS	16
SYMBOL.....	16
SPECIFICATIONS	16
STANDARD ACCESSORIES	17
OPTIONAL ACCESSORIES (sold separately).....	17
APPLICATIONS.....	18
PRIOR TO OPERATION.....	18
HOW TO USE THE DEMOLITION HAMMER.....	19
GREASE REPLACEMENT	19
MAINTENANCE AND INSPECTION	20
SERVICE PARTS LIST	21

GENERAL POWER TOOL SAFETY WARNINGS

WARNING

Read all safety warnings and all instructions.

Failure to follow the warnings and instructions may result in electric shock, fire and/or serious injury.

Save all warnings and instructions for future reference.

The term “power tool” in the warnings refers to your mains-operated (corded) power tool or battery-operated (cordless) power tool.

- 1) **Work area safety**
 - a) **Keep work area clean and well lit.**
Cluttered or dark areas invite accidents.
 - b) **Do not operate power tools in explosive atmospheres, such as in the presence of flammable liquids, gases or dust.**
Power tools create sparks which may ignite the dust or fumes.
 - c) **Keep children and bystanders away while operating a power tool.**
Distractions can cause you to lose control.
- 2) **Electrical safety**
 - a) **Power tool plugs must match the outlet.**
Never modify the plug in any way.
Do not use any adapter plugs with earthed (grounded) power tools.
Unmodified plugs and matching outlets will reduce risk of electric shock.
 - b) **Avoid body contact with earthed or grounded surfaces, such as pipes, radiators, ranges and refrigerators.**
There is an increased risk of electric shock if your body is earthed or grounded.

English

- c) **Do not expose power tools to rain or wet conditions.**
Water entering a power tool will increase the risk of electric shock.
- d) **Do not abuse the cord. Never use the cord for carrying, pulling or unplugging the power tool.**
Keep cord away from heat, oil, sharp edges or moving parts.
Damaged or entangled cords increase the risk of electric shock.
- e) **When operating a power tool outdoors, use an extension cord suitable for outdoor use.**
Use of a cord suitable for outdoor use reduces the risk of electric shock.
- f) **If operating a power tool in a damp location is unavoidable, use a residual current device (RCD) protected supply.**
Use of an RCD reduces the risk of electric shock.

3) Personal safety

- a) **Stay alert, watch what you are doing and use common sense when operating a power tool.**
Do not use a power tool while you are tired or under the influence of drugs, alcohol or medication.
A moment of inattention while operating power tools may result in serious personal injury.
- b) **Use personal protective equipment. Always wear eye protection.**
Protective equipment such as dust mask, non-skid safety shoes, hard hat, or hearing protection used for appropriate conditions will reduce personal injuries.
- c) **Prevent unintentional starting. Ensure the switch is in the off position before connecting to power source and/or battery pack, picking up or carrying the tool.**
Carrying power tools with your finger on the switch or energising power tools that have the switch on invites accidents.
- d) **Remove any adjusting key or wrench before turning the power tool on.**
A wrench or a key left attached to a rotating part of the power tool may result in personal injury.
- e) **Do not overreach. Keep proper footing and balance at all times.**
This enables better control of the power tool in unexpected situations.
- f) **Dress properly. Do not wear loose clothing or jewellery. Keep your hair, clothing and gloves away from moving parts.**
Loose clothes, jewellery or long hair can be caught in moving parts.
- g) **If devices are provided for the connection of dust extraction and collection facilities, ensure these are connected and properly used.**
Use of dust collection can reduce dust-related hazards.

4) Power tool use and care

- a) **Do not force the power tool. Use the correct power tool for your application.**
The correct power tool will do the job better and safer at the rate for which it was designed.
- b) **Do not use the power tool if the switch does not turn it on and off.**
Any power tool that cannot be controlled with the switch is dangerous and must be repaired.

- c) **Disconnect the plug from the power source and/or the battery pack from the power tool before making any adjustments, changing accessories, or storing power tools.**

Such preventive safety measures reduce the risk of starting the power tool accidentally.

- d) **Store idle power tools out of the reach of children and do not allow persons unfamiliar with the power tool or these instructions to operate the power tool.**

Power tools are dangerous in the hands of untrained users.

- e) **Maintain power tools. Check for misalignment or binding of moving parts, breakage of parts and any other condition that may affect the power tool's operation.**

If damaged, have the power tool repaired before use.

Many accidents are caused by poorly maintained power tools.

- f) **Keep cutting tools sharp and clean.**

Properly maintained cutting tools with sharp cutting edges are less likely to bind and are easier to control.

- g) **Use the power tool, accessories and tool bits etc. in accordance with these instructions, taking into account the working conditions and the work to be performed.**

Use of the power tool for operations different from those intended could result in a hazardous situation.

5) Service

- a) **Have your power tool serviced by a qualified repair person using only identical replacement parts.**

This will ensure that the safety of the power tool is maintained.

CAUTION

Keep children and infirm persons away.

When not in use, tools should be stored out of reach of children and infirm persons.

DEMOLITION HAMMER SAFETY WARNINGS

1. **Wear ear protections**
Exposure to noise can cause hearing loss.
2. **Use auxiliary handles supplied with the tool.**
Loss of control can cause personal injury.
3. **Hold power tool by insulated gripping surfaces, when performing an operation where the cutting accessory may contact hidden wiring or its own cord. Cutting accessory contacting a "live" wire may make exposed metal parts of the power tool "live" and could give the operator an electric shock.**

ADDITIONAL SAFETY WARNINGS

1. Ensure that the power source to be utilized conforms to the power requirements specified on the product nameplate.
2. Ensure that the power switch is in the OFF position.
If the plug is connected to a receptacle while the power switch is in the ON position, the power tool will start operating immediately, which could cause a serious accident.
3. When the work area is removed from the power source, use an extension cord of sufficient thickness and rated capacity. The extension cord should be kept as short as practicable.
4. RCD
The use of a residual current device with a rated residual current of 30mA or less at all times is recommended.
5. Do not touch the bit during or immediately after operation. The bit becomes very hot during operation and could cause serious burns.
6. Before starting to break, chip or drill into a wall, floor or ceiling, thoroughly confirm that such items as electric cables or conduits are not buried inside.
7. Wear a mask when turning your head upward.
8. Properly set the bit holder.
9. At the start of work, confirm screw tightening.
10. When working at a highly elevated location, pay attention to articles and persons below.
11. Wear protective shoes to protect your feet.

SYMBOL

WARNING

The following show symbols used for the machine. Be sure that you understand their meaning before use.

	To reduce the risk of injury, user must read instruction manual.		Class II tool
--	--	---	---------------

SPECIFICATIONS

Voltage	220 V ~	Full-load Impact Rate	1400 /min
Power Input	1340 W	Weight	18.0 kg

STANDARD ACCESSORIES

In addition to the main unit (1 unit), the package contains the accessories listed in the below.

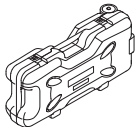
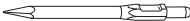
Case Code No. 339664		1
Bull Point Code No. 944961		1

OPTIONAL ACCESSORIES (sold separately)

- Demolishing

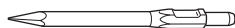

- (1) Bull Point
Overall Length: 410 mm
Code No.: 944961

- Asphalt Cutting

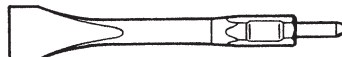

- (1) Cutter
Overall Length: 410 mm
Width: 75 mm
Code No.: 944964

- Groove Digging and Edging

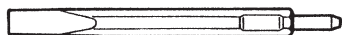

- (1) Cold Chisel
Overall Length: 410 mm
Code No.: 944962

- Scooping Work

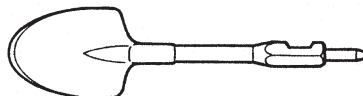

- (1) Scoop
Overall Length: 380 mm
Code No.: 957154

- Tamping

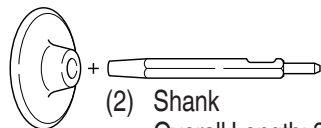

- (2) Shank
Overall Length: 250 mm
Code No.: 944966
- (1) Rammer
Outer diameter: 200 mm
Code No.: 944965

- Hexagonal bar wrench



- 6 MM: Code No.: 872422
3 MM: Code No.: 943277

- Grease

- 500 g (in a can) Code No.: 980927
30 g (in a tube) Code No.: 981840

- Carbon brush

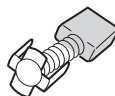

- Code No.: 999086

APPLICATIONS

Demolishing concrete, chiseling off concrete, grooving, bar cutting.

Application examples:

Installation of piping and wiring, sanitary facility installation, machinery installation, water supply and drainage work, interior jobs, harbor facilities and other civil engineering works.

PRIOR TO OPERATION

1. Power source
Ensure that the power source to be utilized conforms to the power requirements specified on the product nameplate.
2. Power switch
Ensure that the power switch is in the OFF position. If the plug is connected to a receptacle while the power switch is in the ON position, the power tool will start operating immediately, which could cause a serious accident.
3. Extension cord
When the work area is remote from the power source, use an extension cord of sufficient thickness and rated capacity. The extension cord should be kept as short as practicable.
4. Mounting a tool

NOTE

For tools such as a bull point and a cold chisel, use only genuine HiKOKI parts.

- (1) Clean, then smear the tool shank with grease or machine oil (**Fig.1**).
- (2) Rotate the stop lever 180° in a clockwise direction while pulling it toward you. Next, insert the tool shank into the hexagonal hole on the front cover (**Fig.1**).
If the tool's entire notched portion isn't inserted beyond the front cover's end surface, lightly tap the tool using a hammer or other object to insert it.
- (3) Clamp the tool by turning the stop lever by half a turn in the opposite direction (**Fig.2**).

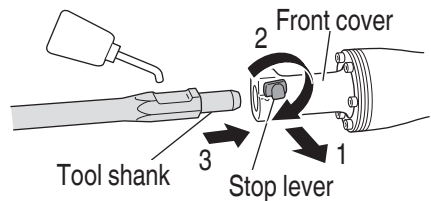

Fig. 1

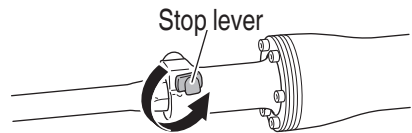

Fig. 2

HOW TO USE THE DEMOLITION HAMMER

1. Switch operation

The switch turns ON when it is pulled, and turns OFF when it is released.

While the switch is pulled all the way, if the push button is pushed toward "A", the switch becomes locked and stays ON even if your finger releases it, enabling continuous operation. (**Fig. 3**)

To release the lock, push the push button toward "B". (**Fig. 4**)

2. Squeeze the trigger switch after applying the tip of the bit to the crushing position.

In some cases, it is necessary to punch the tip of the bit against the crushing position forcibly in order to begin the striking motion.

This is not due to malfunction of the tool. It means that the safe guard mechanism against no-load striking is working.

3. Operate the tool by utilizing its empty weight. The performance will not be better even if the tool is pressed or thrust forcibly against the work surface. Hold the tool with a force just sufficient to counteract the reaction (**Fig. 5**).

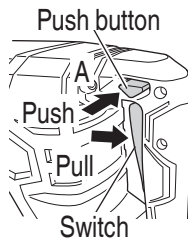

Fig. 3

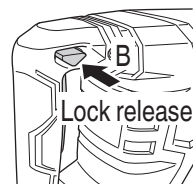

Fig. 4

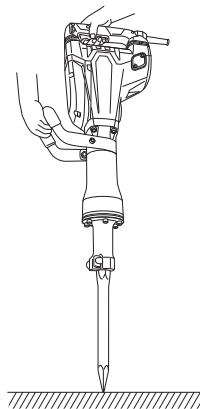

Fig. 5

GREASE REPLACEMENT

This machine is of full air-tight construction to protect against dust and to prevent lubricant leakage. Therefore, the machine can be used without lubrication for long periods. Replace the grease as described below.

Grease Replacement Period

After purchase, replace grease after every 6 months of usage. Ask for grease replacement at the nearest authorized HiKOKI Service Center.

MAINTENANCE AND INSPECTION

CAUTION

Be sure to switch OFF and disconnect the attachment plug from the receptacle to avoid a serious accident.

1. Inspecting the tool
Since use of a dull tool will degrade efficiency and cause possible motor malfunction, sharpen or replace the tool as soon as abrasion is noted.
2. Inspecting the mounting screws
Regularly inspect all mounting screws and ensure that they are properly tightened. Should any of the screws be loose, retighten them immediately. Failure to do so could result in serious hazard.
3. Maintenance of the motor
The motor unit winding is the very “heart” of the power tool. Exercise due care to ensure the winding does not become damaged and/or wet with oil or water.

4. Inspecting the carbon brushes (**Fig. 6**)
The Motor employs carbon brushes which are consumable parts. When they become worn to or near the “wear limit”, it could result in motor trouble. When an auto-stop carbon brush is equipped, the motor will stop automatically. At that time, replace both carbon brushes with new ones which have the same carbon brush Numbers shown in the figure. In addition, always keep carbon brushes clean and ensure that they slide freely within the brush holders.

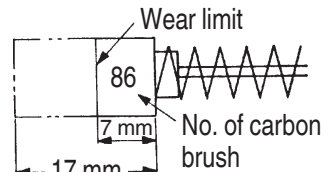
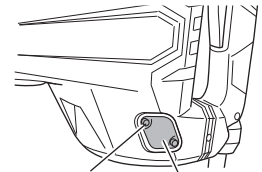

Fig. 6

5. Replacing carbon brushes
Loosen the screws (Hexagon socket hd. bolt M4×8) of the cap covers, then remove the cap covers (**Fig. 7**). After removing the brush caps, the carbon brushes can be removed.
After replacing the carbon brushes, tighten the brush caps, then mount the cap covers securely.



Hexagon socket hd. bolt M4×8 Cap cover

Fig. 7

CAUTION

Repair, modification and inspection of HiKOKI Power Tools must be carried out by a HiKOKI Authorized Service Center.

This Parts List will be helpful if presented with the tool to the HiKOKI Authorized Service Center when requesting repair or other maintenance.

In the operation and maintenance of power tools, the safety regulations and standards prescribed in each country must be observed.

SERVICE PARTS LIST

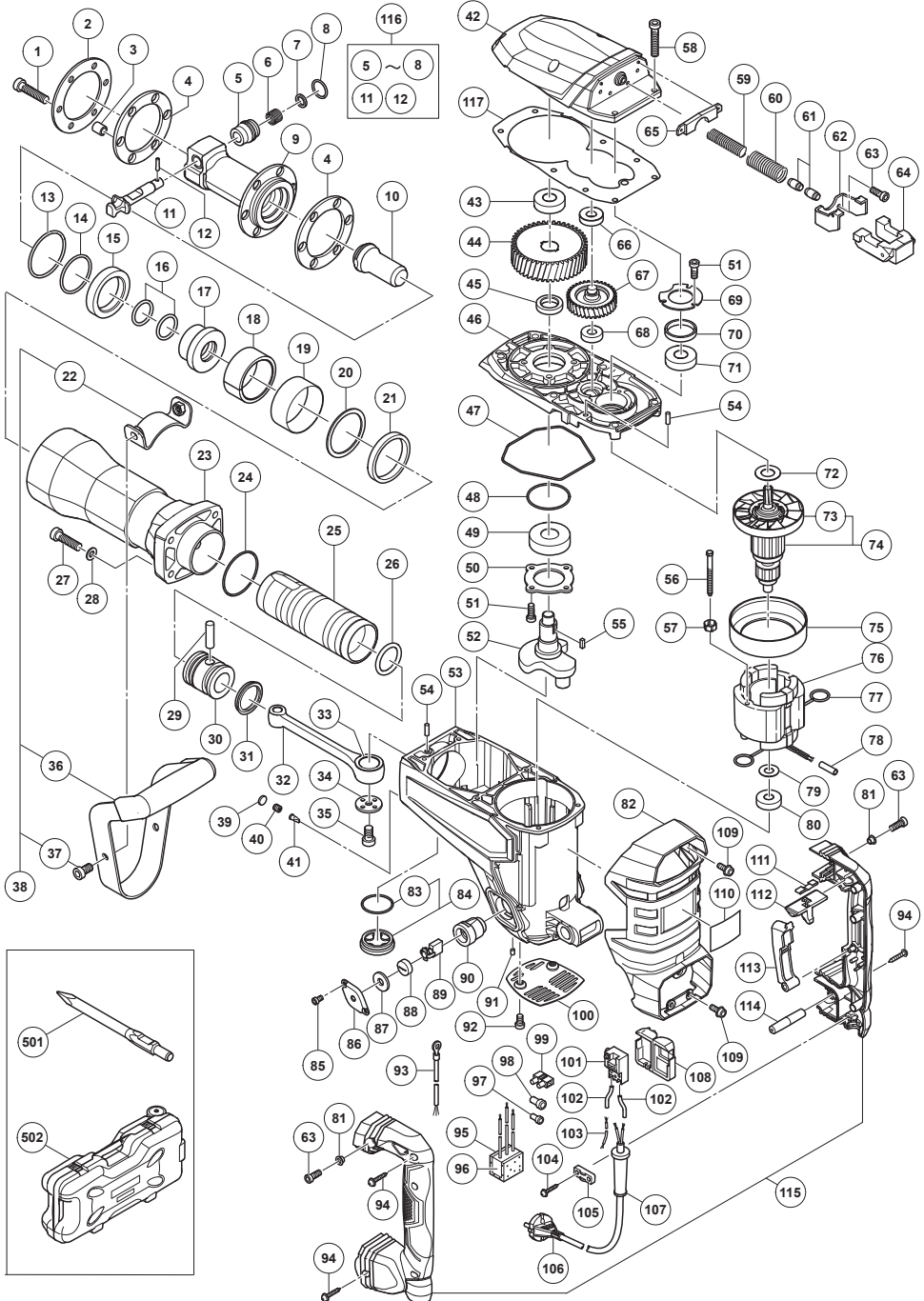

English

Item No.	Part Name	Q'TY
1	NYLOCK HEX. SOCKET HD. BOLT M8 × 40	6
2	DAMPER PLATE	1
3	COLLAR	6
4	FRONT DAMPER	2
5	SPRING CASE	1
6	LEVER SPRING	1
7	DAMPER (B)	1
8	RING	1
9	FRONT COVER	1
10	SECOND HAMMER	1
11	STOP LEVER	1
12	NEEDLE ROLLER	1
13	O-RING (C)	1
14	O-RING (B)	1
15	DAMPER (A)	1
16	O-RING	2
17	SHANK SLEEVE	1
18	MOUTH	1
19	MOUTH COVER	1
20	MOUTH WASHER (A)	1
21	URETHANE RING (A)	1
22	HANDLE STAY (W/NUT)	1
23	CYLINDER CASE	1
24	O-RING (1AS-60)	1
25	STRIKER	1
26	O-RING (A)	1
27	NYLOCK HEX. SOCKET HD. BOLT M8 × 40	4
28	BOLT WASHER M8 (BLACK)	4
29	PISTON PIN	1
30	PISTON	1
31	OIL SEAL (A)	1
32	CONNECTING ROD ASS'Y	1
33	NEEDLE BEARING (NTN 8E-NK 18/20 RDO)	1
34	CRANK WASHER	1

Item No.	Part Name	Q'TY
35	SEAL LOCK HEX. SOCKET HD. BOLT M8 × 16	1
36	GRIP	1
37	NYLOCK HEX. SOCKET HD. BOLT M8 × 16	2
38	SIDE HANDLE ASS'Y	1
39	FELT PACKING (B)	1
40	CAP SCREW	1
41	VALVE	1
42	GEAR COVER	1
43	BALL BEARING 6302VVCMP52L	1
44	FINAL GEAR	1
45	DISTANCE RING (B)	1
46	INNER COVER	1
47	SEAL RING	1
48	O-RING	1
49	BALL BEARING 6205DDCMP52L	1
50	BEARING COVER	1
51	SEAL LOCK HEX. SOCKET HD. BOLT M5 × 16	7
52	CRANK SHAFT	1
53	HOUSING ASS'Y	1
54	PIN D5 × 15.8	2
55	FEATHER KEY 4 × 4 × 12	1
56	HEX. HD. TAPPING SCREW D5 × 65	2
57	SPECIAL WASHER	2
58	SEAL LOCK HEX. SOCKET HD. BOLT M6 × 40	6
59	HANDLE SPRING (B)	1
60	HANDLE SPRING (A)	1
61	HANDLE DAMPER	2
62	HANDLE GUIDE	1
63	SEAL LOCK HEX. SOCKET HD. BOLT M5 × 16	4
64	HANDLE WEIGHT	1
65	HANDLE STOPPER	1

Item No.	Part Name	Q'TY
66	BALL BEARING 6201VV	1
67	COUNTER GEAR	1
68	BALL BEARING 6001VV	1
69	BEARING COVER (A)	1
70	DISTANCE RING (A)	1
71	BALL BEARING 6203DDCMPS2L	1
72	BEARING WASHER	1
73	FAN	1
74	ARMATURE ASS'Y 220V-230V	1
75	FAN GUIDE	1
76	STATOR ASS'Y 220V-230V	1
77	BRUSH TERMINAL	2
78	VINYL TUBE L55	1
79	BEARING WASHER	1
80	BALL BEARING 6201DDCMPS2L	1
81	DISTANCE PIECE (B)	2
82	BACK COVER	1
83	O-RING (S-38)	1
84	OIL CAP ASS'Y	1
85	SEAL LOCK HEX. SOCKET HD. BOLT M4 × 8	4
86	CAP COVER	2
87	CAP RUBBER	2
88	BRUSH CAP	2
89	CARBON BRUSH (AUTO STOP TYPE) (1 PAIR)	2
90	BRUSH HOLDER	2
91	HEX. SOCKET SET SCREW M5 × 8	2
92	SEAL LOCK HEX. SOCKET HD. BOLT M5 × 12	2
93	INTERNAL WIRE	1
94	TAPPING SCREW (W/FLANGE) D4 × 25 (BLACK)	5
95	SUPPORT (B)	1
96	NOISE SUPPRESSOR	1

Item No.	Part Name	Q'TY
97	CONNECTOR 50091 (10 PCS.)	1
98	CONNECTOR 50092 (10 PCS.)	1
99	PILLAR TERMINAL	1
100	TAIL COVER	1
101	SWITCH	1
102	VINYL TUBE (A) (I.D.7 × T0.5 × 50)	2
103	INTERNAL WIRE (BLACK)	1
104	TAPPING SCREW (W/FLANGE) D4 × 16	2
105	CORD CLIP	1
106	CORD	1
107	CORD ARMOR D10.7	1
108	SUPPORT	1
109	NYLOCK BOLT (W/FLANGE) M5	4
110	NAME PLATE	1
111	LEAF SPRING	1
112	PUSHING BUTTON	1
113	SWITCH LEVER	1
114	HANDLE SHAFT	1
115	HANDLE (A).(B) SET	1
116	STOP LEVER ASS'Y	1
117	SEAL PACKING	1
501	BULL POINT 410MM	1
502	CASE (PLASTIC)	1

服务中心
工机商业(中国)有限公司
上海市闵行区浦江工业园区三鲁路3585号7幢3楼

制造商
高壹工机(马来西亚)有限公司
马来西亚柔佛州士乃第二工业区

Koki Holdings Co., Ltd.

806
编号: C99716524 M
发行日期: 2018年6月
马来西亚印刷